



DM-BO1a[172-173]



DM-BO2a[174-175]



DM-BO3a[176-177]



DM-BO4a[178-179]



DM-BO5a-h[180-188]



DM-BO6a-d[189-193]



DM-BO7a[194-195]



DM-BO8a-d[196-200]



DM-BO9a[201-202]



DM-BO10a-e[203-208]



DM-BO11a-b[209-211]



DM-BO12a[212-213]



DM-BO13a[214-215]



DM-BO14a[216-217]



DM-BO15a[218-219]



DM-BO16a[220-221]



DM-BO17a[222-223]



DM-BO18a[224-225]



DM-BO19a[226-227]



DM-BO20a[228-229]



DM-BO21a[230-231]



DM-BO22a[232-233]



DM-BO23a[234-235]



DM-BO24a[236-237]



DM-BO25a[238-239]



DM-BO26a[240-241]



DM-BO27a[242-243]



DM-BO28a[244-245]



DM-BO29a[246-247]



DM-BO30a[248-249]



DM-BO31a[250-251]



DM-BO32a[252-253]



DM-BO33a[254-255]



DM-BO34a[256-257]



DM-BO35a[258-259]



DM-BO36a[260-261]



DM-BO37a[262-263]



DM-BO38a[264-265]

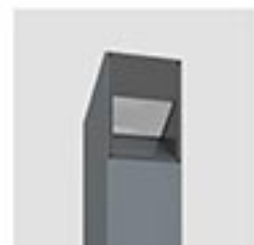

DM-BO39a~b[266-268]



DM-BO40a[269-270]



DM-BO41a[271-272]



DM-BO42a[273-274]



DM-BO43a[275-276]



DM-BO44a[277-278]



DM-BO45a[279-280]



DM-BO46a[281-282]



DM-BO47a[283-284]



DM-BO48a[285-286]



DM-BO49a[287-288]



DM-BO50a[289-290]



DM-BO51a[291-292]



DM-BO52a[293-294]



DM-BO53a[295-296]



DM-BO54a[297-298]



DM-BO55a-e[299-303]



DM-BO56a[304-305]



DM-BO57a[306-307]



DM-BO58a[308-309]



DM-BO59a[310-311]



DM-BO60a[312]



DM-BO61a[313]



DM-BO62a[314]



DM-BO63a[315-316]



DM-BO64a[317-318]



DM-BO65a[319-320]



DM-BO66a[321-322]



DM-BO67a[323]



DM-BO68a[324]



DM-BO69a[325]



DM-BO70a[326]



DM-BO71a[327]



DM-BO72a[328]



DM-BO73a[329]



DM-BO74a[330]



DM-BO75a[331]



DM-BO76a[332]



DM-BO77a[333]



DM-BO78a[334]



DM-BO79a[335]



DM-BO80a[336-337]



DM-BO81a[338]



DM-BO82a[339]



DM-BO83a[340]



DM-BO84a[341]



DM-BO85a[342]



DM-BO86a[343]



DM-BO87a[344-345]



DM-BO88a[346]



DM-BO89a[347]



DM-BO90a[348]



DM-BO91a[349]



DM-BO92a[350]



DM-BO93a[351]



DM-BO94a[352]



DM-BO95a[353]



DM-BO96a[354]



DM-BO97a[355]



DM-BO98a[356]



DM-BO99a[357]



DM-BO100a[358]



DM-BO101a[359]



DM-BO102a[360-361]



DM-BO103a[362]



DM-BO104a[363]



DM-BO105a[364]



DM-BO106a[365]



DM-BO107a[366]



DM-BO108a[367]



DM-BO109a[368]



DM-BO110a[369]



DM-BO111a[370]



DM-BO112a[371]



DM-BO113a[372]



DM-BO114a[373]



DM-BO115a[374]



DM-BO116a[375]



DM-BO117a[376]



DM-BO118a[377]



DM-BO119a[378]



DM-BO120a[379]



DM-BO121a[380]



DM-BO122a[381]



DM-BO123a[382]



DM-BO124a[383]



DM-BO125a[384-385]

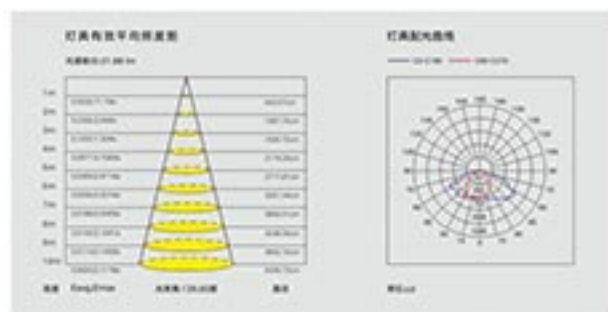
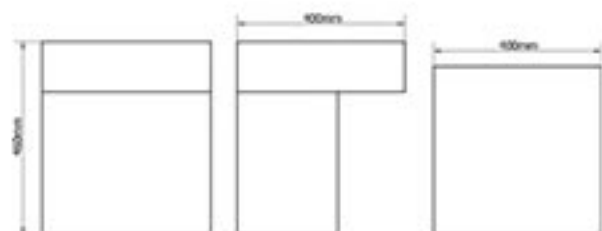

GENERAL PARAMETRES

常规参数

Rated power	额定功率
LED Quantity	LED数量
Color Temperature	色温
Luminous Flux	初始光通量
Input Voltage	输入电压
Protection Grade	防护等级
Operating Temperature	工作环境温度
Power Factor	功率因素
Life	使用寿命
THD	总谐波失真
Frequency Range	频率范围
Installation Pipe Diameter	安装管径
CRI	显色指数

10W
10pcs
6000k/4000k/3000k
1100lm
AC100~277V
IP65
-30~50°C
>0.9
>50000H
<15%
50/60HZ
/
>70



草坪灯 BOLLARD LIGHT

IP65 CCC CE

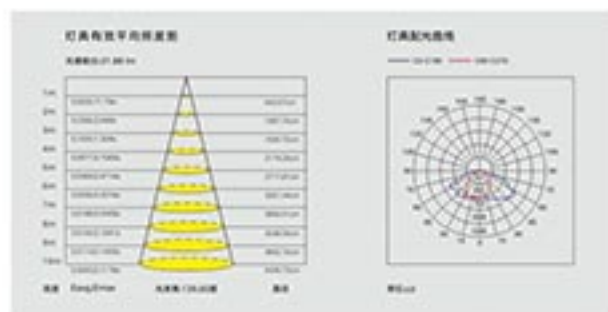
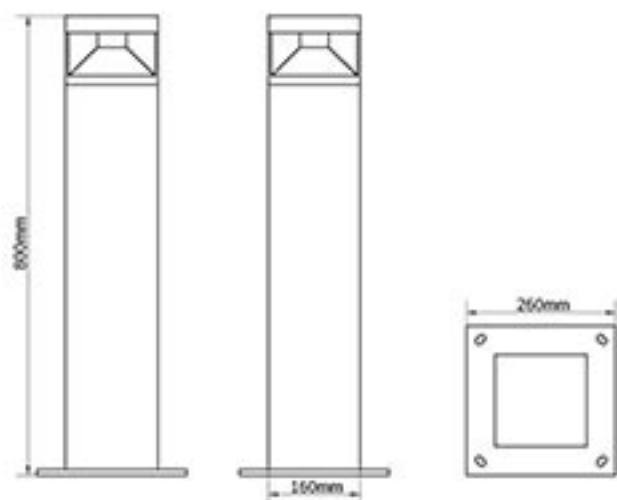
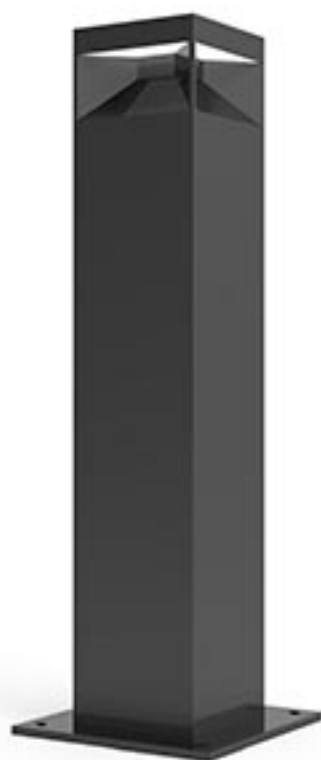

GENERAL PARAMETRES

常规参数

Rated power	额定功率
LED Quantity	LED数量
Color Temperature	色温
Luminous Flux	初始光通量
Input Voltage	输入电压
Protection Grade	防护等级
Operating Temperature	工作环境温度
Power Factor	功率因素
Life	使用寿命
THD	总谐波失真
Frequency Range	频率范围
Installation Pipe Diameter	安装管径
CRI	显色指数

10W
10pcs
6000k/4000k/3000k
1100lm
AC100~277V
IP65
-30~50°C
>0.9
>50000H
<15%
50/60HZ
/
>70

草坪灯 BOLLARD LIGHT

IP65 CCC CE



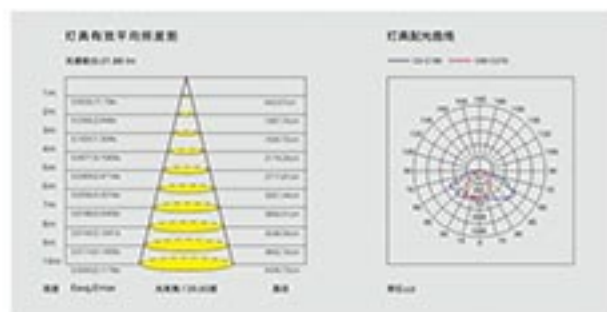
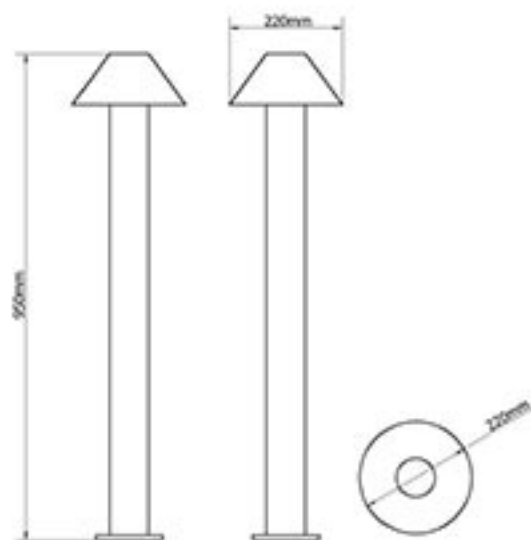

GENERAL PARAMETRES

常规参数

Rated power	额定功率
LED Quantity	LED数量
Color Temperature	色温
Luminous Flux	初始光通量
Input Voltage	输入电压
Protection Grade	防护等级
Operating Temperature	工作环境温度
Power Factor	功率因素
Life	使用寿命
THD	总谐波失真
Frequency Range	频率范围
Installation Pipe Diameter	安装管径
CRI	显色指数

6W
6pcs
6000k/4000k/3000k
660lm
AC100~277V
IP65
-30~50°C
>0.9
>50000H
<15%
50/60HZ
/
>70



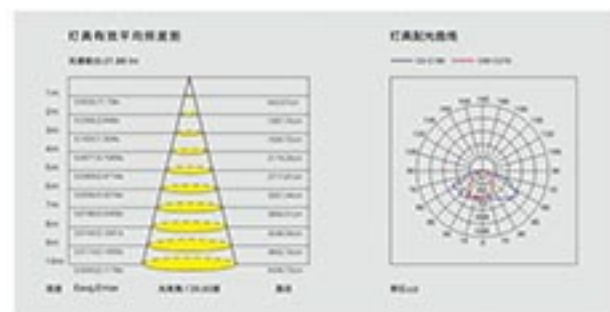
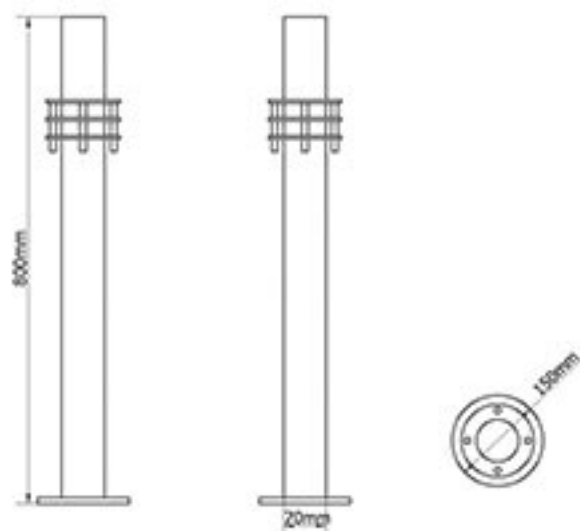

GENERAL PARAMETRES

常规参数

Rated power	额定功率
LED Quantity	LED数量
Color Temperature	色温
Luminous Flux	初始光通量
Input Voltage	输入电压
Protection Grade	防护等级
Operating Temperature	工作环境温度
Power Factor	功率因素
Life	使用寿命
THD	总谐波失真
Frequency Range	频率范围
Installation Pipe Diameter	安装管径
CRI	显色指数

10W
1pcs
6000k/4000k/3000k
1100lm
AC100~277V
IP65
-30~50°C
>0.9
>50000H
<15%
50/60HZ
/
>70



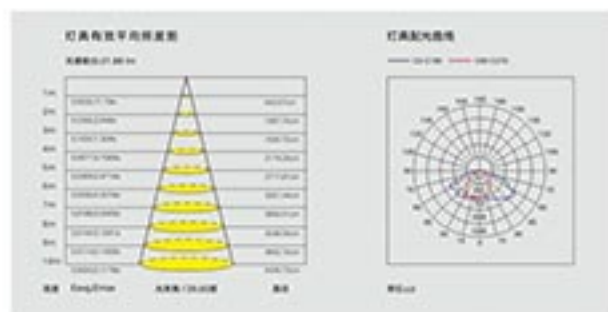
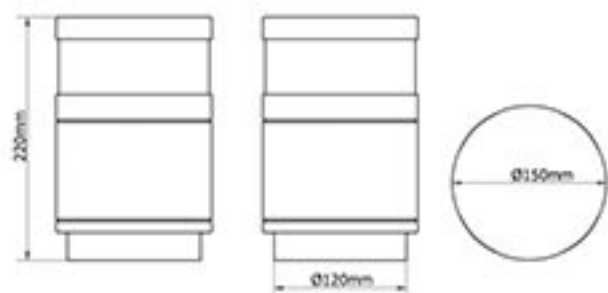

GENERAL PARAMETRES

常规参数

Rated power	额定功率
LED Quantity	LED数量
Color Temperature	色温
Luminous Flux	初始光通量
Input Voltage	输入电压
Protection Grade	防护等级
Operating Temperature	工作环境温度
Power Factor	功率因素
Life	使用寿命
THD	总谐波失真
Frequency Range	频率范围
Installation Pipe Diameter	安装管径
CRI	显色指数

10W
10pcs
6000k/4000k/3000k
1100lm
AC100~277V
IP65
-30~50°C
>0.9
>50000H
<15%
50/60HZ
/
>70

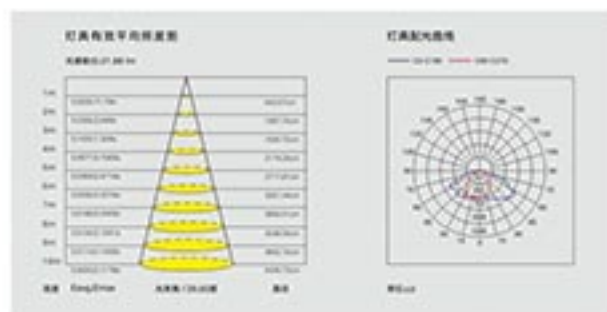
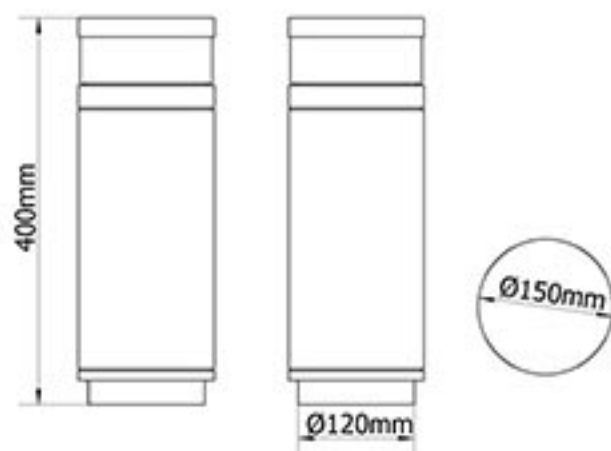
GENERAL PARAMETRES
常规参数

Rated power	额定功率
LED Quantity	LED数量
Color Temperature	色温
Luminous Flux	初始光通量
Input Voltage	输入电压
Protection Grade	防护等级
Operating Temperature	工作环境温度
Power Factor	功率因素
Life	使用寿命
THD	总谐波失真
Frequency Range	频率范围
Installation Pipe Diameter	安装管径
CRI	显色指数

10W
10pcs
6000k/4000k/3000k
1100lm
AC100~277V
IP65
-30~50°C
>0.9
>50000H
<15%
50/60HZ
/
>70

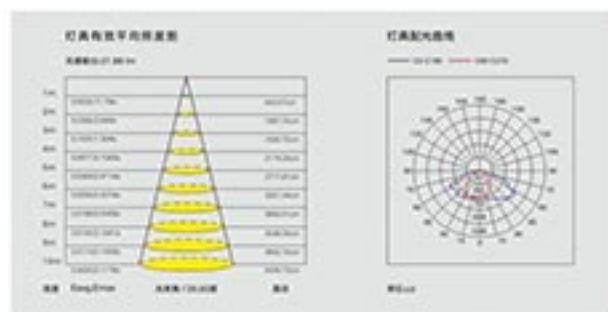
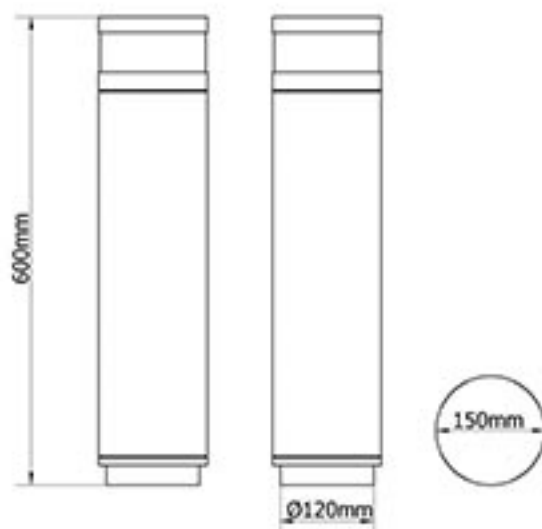

GENERAL PARAMETRES

常规参数

Rated power	额定功率
LED Quantity	LED数量
Color Temperature	色温
Luminous Flux	初始光通量
Input Voltage	输入电压
Protection Grade	防护等级
Operating Temperature	工作环境温度
Power Factor	功率因素
Life	使用寿命
THD	总谐波失真
Frequency Range	频率范围
Installation Pipe Diameter	安装管径
CRI	显色指数

10W
10pcs
6000k/4000k/3000k
1100lm
AC100~277V
IP65
-30~50°C
>0.9
>50000H
<15%
50/60HZ
/
>70

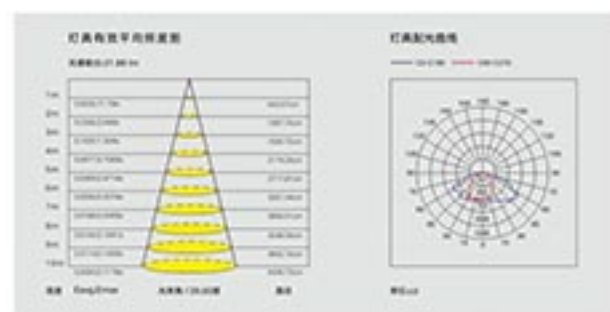
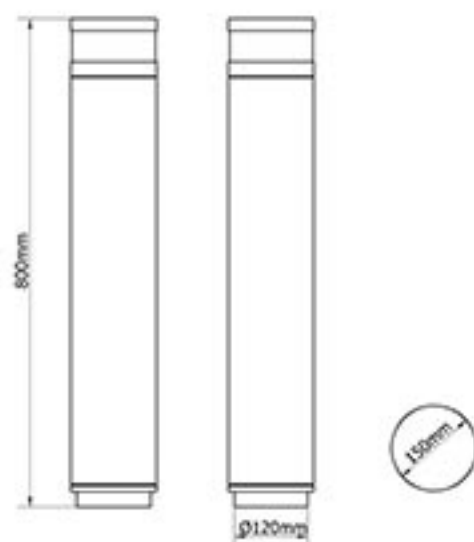

GENERAL PARAMETRES

常规参数

Rated power	额定功率
LED Quantity	LED数量
Color Temperature	色温
Luminous Flux	初始光通量
Input Voltage	输入电压
Protection Grade	防护等级
Operating Temperature	工作环境温度
Power Factor	功率因素
Life	使用寿命
THD	总谐波失真
Frequency Range	频率范围
Installation Pipe Diameter	安装管径
CRI	显色指数

10W
10pcs
6000k/4000k/3000k
1100lm
AC100~277V
IP65
-30~50°C
>0.9
>50000H
<15%
50/60HZ
/
>70

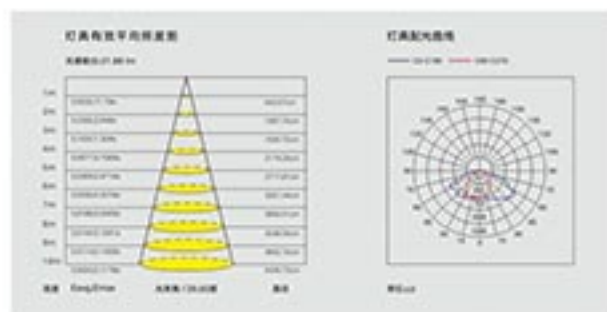
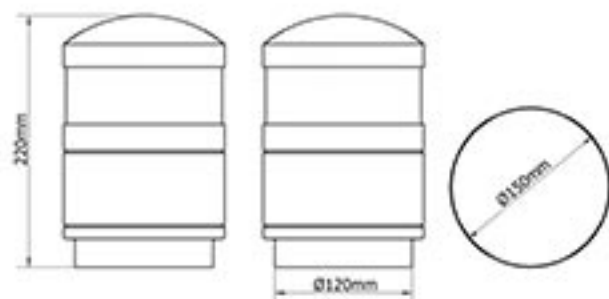

GENERAL PARAMETRES

常规参数

Rated power	额定功率
LED Quantity	LED数量
Color Temperature	色温
Luminous Flux	初始光通量
Input Voltage	输入电压
Protection Grade	防护等级
Operating Temperature	工作环境温度
Power Factor	功率因素
Life	使用寿命
THD	总谐波失真
Frequency Range	频率范围
Installation Pipe Diameter	安装管径
CRI	显色指数

10W
10pcs
6000k/4000k/3000k
1100lm
AC100~277V
IP65
-30~50°C
>0.9
>50000H
<15%
50/60HZ
/
>70

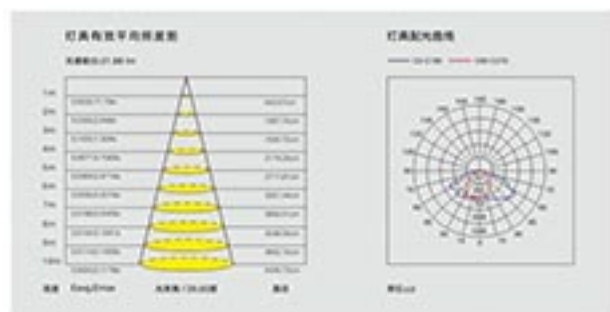
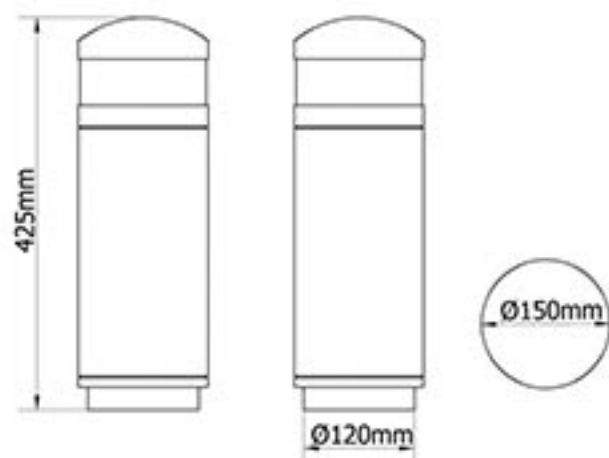
GENERAL PARAMETRES
常规参数

Rated power	额定功率
LED Quantity	LED数量
Color Temperature	色温
Luminous Flux	初始光通量
Input Voltage	输入电压
Protection Grade	防护等级
Operating Temperature	工作环境温度
Power Factor	功率因素
Life	使用寿命
THD	总谐波失真
Frequency Range	频率范围
Installation Pipe Diameter	安装管径
CRI	显色指数

10W
10pcs
6000k/4000k/3000k
1100lm
AC100~277V
IP65
-30~50°C
>0.9
>50000H
<15%
50/60HZ
/
>70

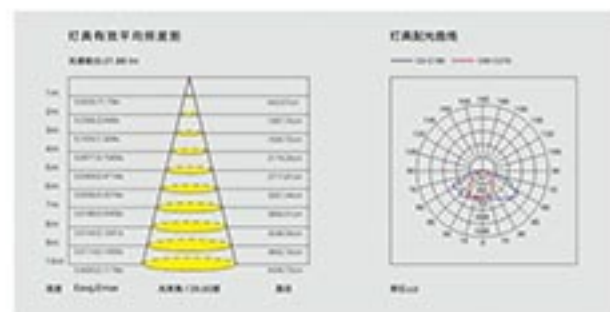
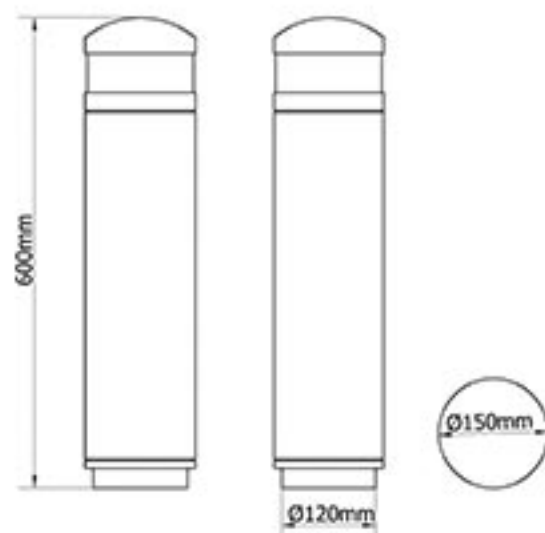
GENERAL PARAMETRES
常规参数

Rated power	额定功率
LED Quantity	LED数量
Color Temperature	色温
Luminous Flux	初始光通量
Input Voltage	输入电压
Protection Grade	防护等级
Operating Temperature	工作环境温度
Power Factor	功率因素
Life	使用寿命
THD	总谐波失真
Frequency Range	频率范围
Installation Pipe Diameter	安装管径
CRI	显色指数

10W
10pcs
6000k/4000k/3000k
1100lm
AC100~277V
IP65
-30~50°C
>0.9
>50000H
<15%
50/60HZ
/
>70

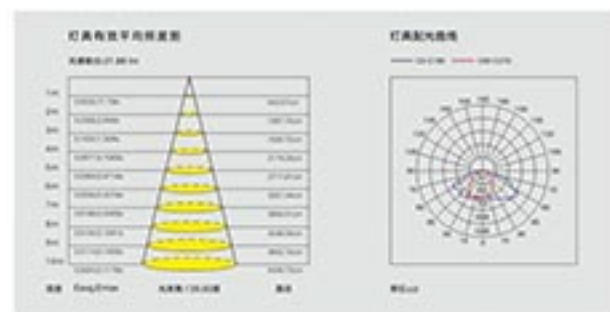
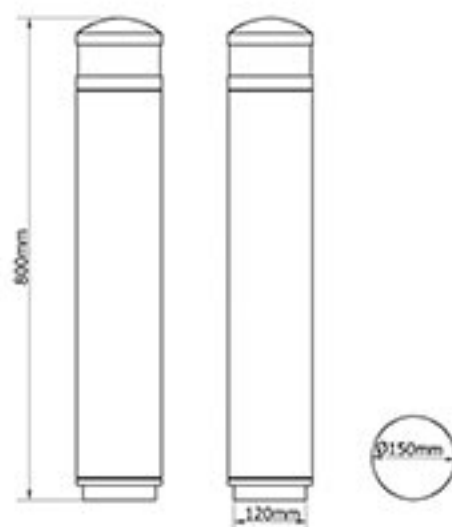
GENERAL PARAMETRES
常规参数

Rated power	额定功率
LED Quantity	LED数量
Color Temperature	色温
Luminous Flux	初始光通量
Input Voltage	输入电压
Protection Grade	防护等级
Operating Temperature	工作环境温度
Power Factor	功率因素
Life	使用寿命
THD	总谐波失真
Frequency Range	频率范围
Installation Pipe Diameter	安装管径
CRI	显色指数

10W
10pcs
6000k/4000k/3000k
1100lm
AC100~277V
IP65
-30~50°C
>0.9
>50000H
<15%
50/60HZ
/
>70

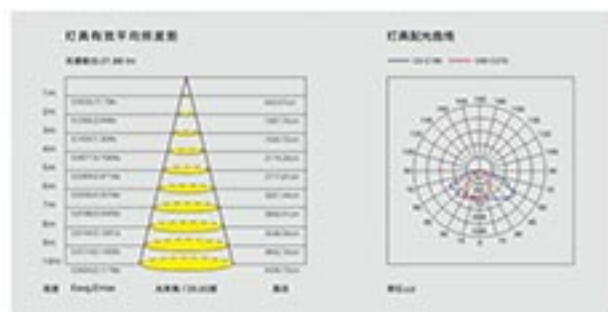
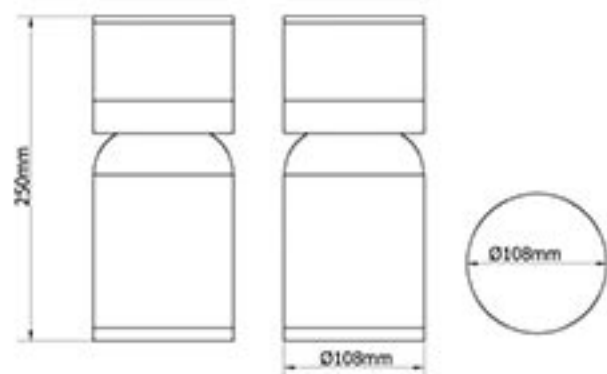
GENERAL PARAMETRES
常规参数

Rated power	额定功率
LED Quantity	LED数量
Color Temperature	色温
Luminous Flux	初始光通量
Input Voltage	输入电压
Protection Grade	防护等级
Operating Temperature	工作环境温度
Power Factor	功率因素
Life	使用寿命
THD	总谐波失真
Frequency Range	频率范围
Installation Pipe Diameter	安装管径
CRI	显色指数

10W
1pcs
6000k/4000k/3000k
1100lm
AC100~277V
IP65
-30~50°C
>0.9
>50000H
<15%
50/60HZ
/
>70

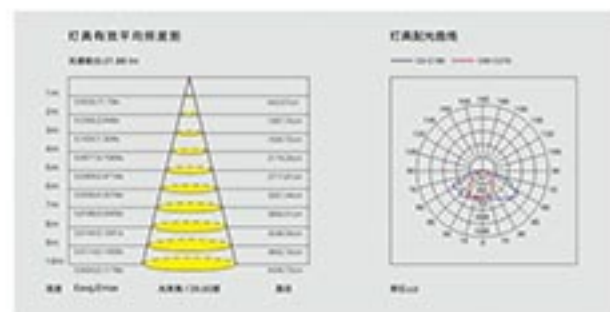
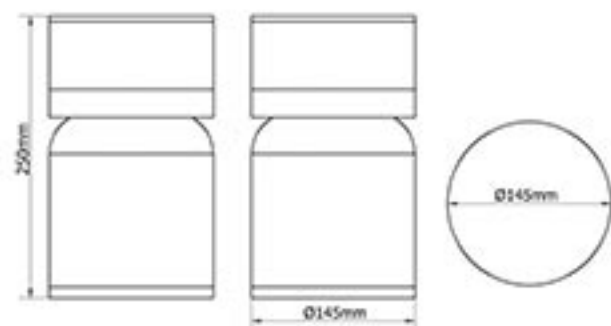

GENERAL PARAMETRES

常规参数

Rated power	额定功率
LED Quantity	LED数量
Color Temperature	色温
Luminous Flux	初始光通量
Input Voltage	输入电压
Protection Grade	防护等级
Operating Temperature	工作环境温度
Power Factor	功率因素
Life	使用寿命
THD	总谐波失真
Frequency Range	频率范围
Installation Pipe Diameter	安装管径
CRI	显色指数

10W
1pcs
6000k/4000k/3000k
1100lm
AC100~277V
IP65
-30~50°C
>0.9
>50000H
<15%
50/60HZ
/
>70

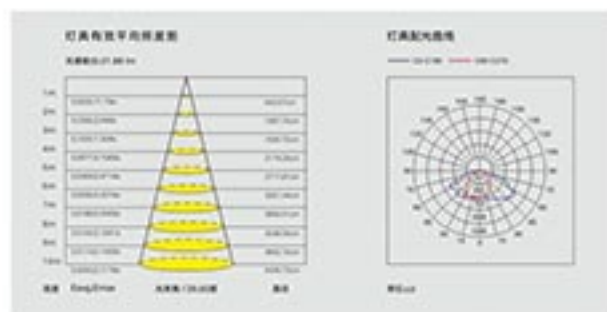
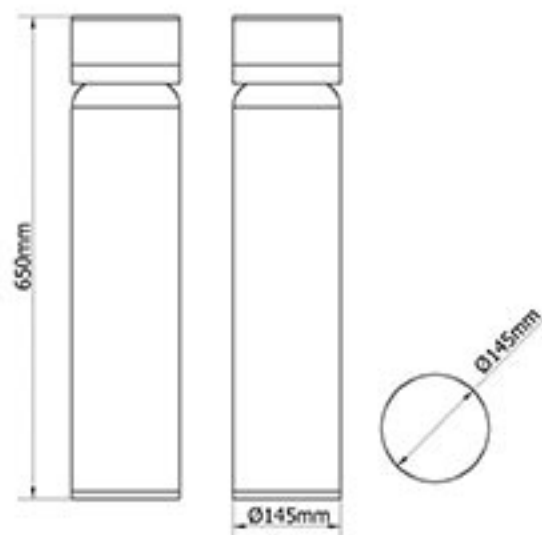

GENERAL PARAMETRES

常规参数

Rated power	额定功率
LED Quantity	LED数量
Color Temperature	色温
Luminous Flux	初始光通量
Input Voltage	输入电压
Protection Grade	防护等级
Operating Temperature	工作环境温度
Power Factor	功率因素
Life	使用寿命
THD	总谐波失真
Frequency Range	频率范围
Installation Pipe Diameter	安装管径
CRI	显色指数

10W
1pcs
6000k/4000k/3000k
1100lm
AC100~277V
IP65
-30~50°C
>0.9
>50000H
<15%
50/60HZ
/
>70

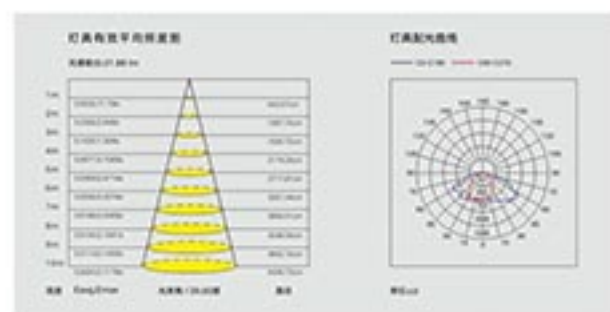
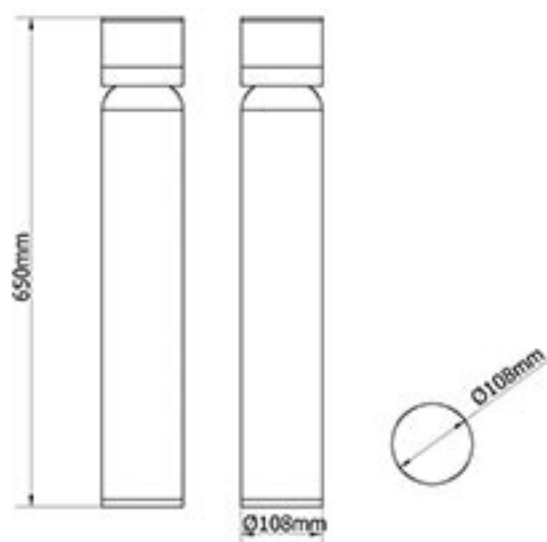

GENERAL PARAMETRES

常规参数

Rated power	额定功率
LED Quantity	LED数量
Color Temperature	色温
Luminous Flux	初始光通量
Input Voltage	输入电压
Protection Grade	防护等级
Operating Temperature	工作环境温度
Power Factor	功率因素
Life	使用寿命
THD	总谐波失真
Frequency Range	频率范围
Installation Pipe Diameter	安装管径
CRI	显色指数

10W
1pcs
6000k/4000k/3000k
1100lm
AC100~277V
IP65
-30~50°C
>0.9
>50000H
<15%
50/60HZ
/
>70



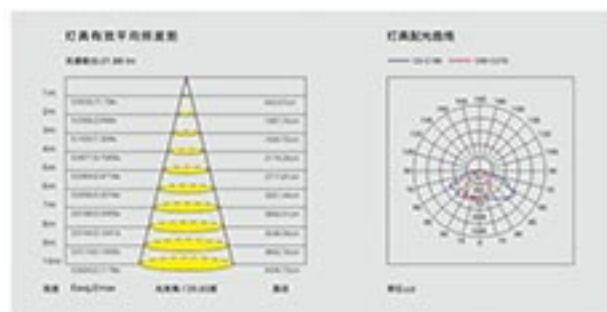
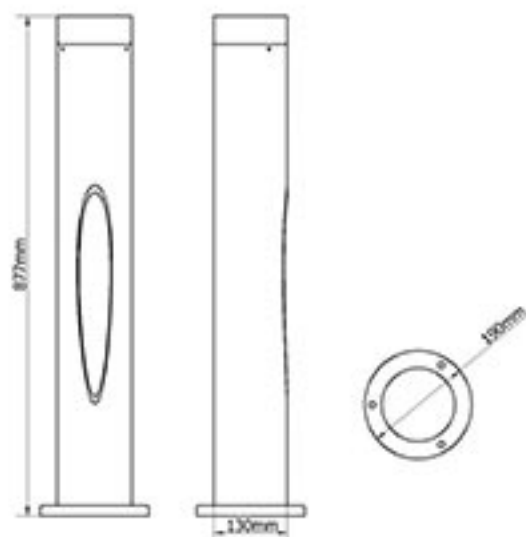

GENERAL PARAMETRES

常规参数

Rated power	额定功率
LED Quantity	LED数量
Color Temperature	色温
Luminous Flux	初始光通量
Input Voltage	输入电压
Protection Grade	防护等级
Operating Temperature	工作环境温度
Power Factor	功率因素
Life	使用寿命
THD	总谐波失真
Frequency Range	频率范围
Installation Pipe Diameter	安装管径
CRI	显色指数

10W
1pcs
6000k/4000k/3000k
1100lm
AC100~277V
IP65
-30~50°C
>0.9
>50000H
<15%
50/60HZ
/
>70

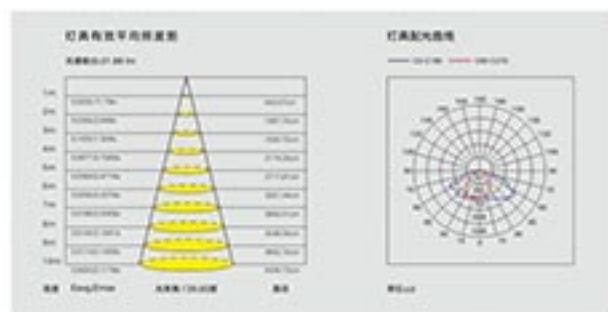
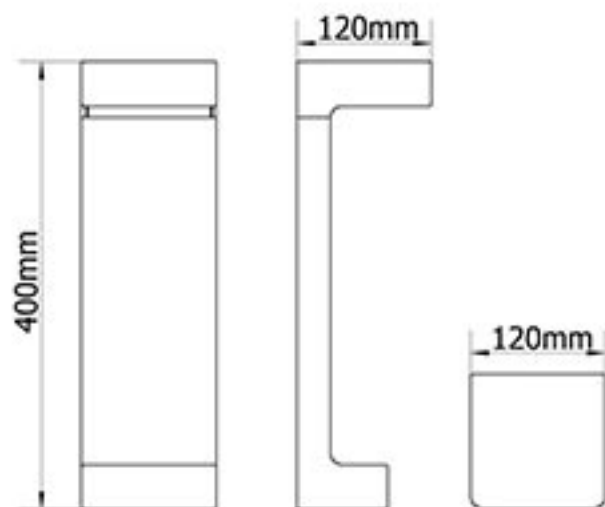
GENERAL PARAMETRES
常规参数

Rated power	额定功率
LED Quantity	LED数量
Color Temperature	色温
Luminous Flux	初始光通量
Input Voltage	输入电压
Protection Grade	防护等级
Operating Temperature	工作环境温度
Power Factor	功率因素
Life	使用寿命
THD	总谐波失真
Frequency Range	频率范围
Installation Pipe Diameter	安装管径
CRI	显色指数

10W
1pcs
6000k/4000k/3000k
1100lm
AC100~277V
IP65
-30~50°C
>0.9
>50000H
<15%
50/60HZ
/
>70

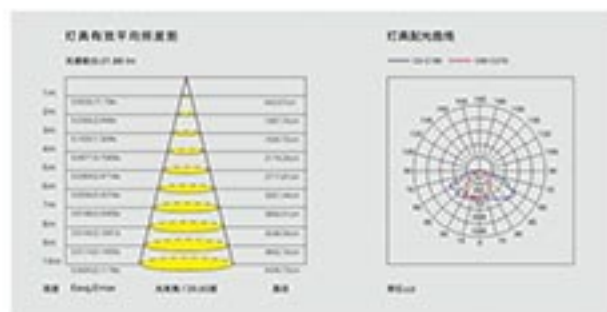
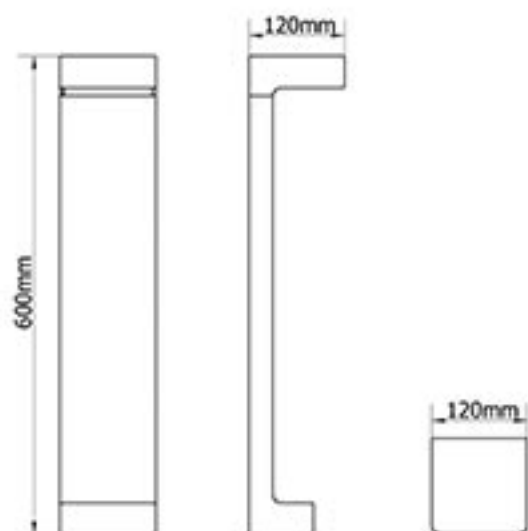

GENERAL PARAMETRES

常规参数

Rated power	额定功率
LED Quantity	LED数量
Color Temperature	色温
Luminous Flux	初始光通量
Input Voltage	输入电压
Protection Grade	防护等级
Operating Temperature	工作环境温度
Power Factor	功率因素
Life	使用寿命
THD	总谐波失真
Frequency Range	频率范围
Installation Pipe Diameter	安装管径
CRI	显色指数

10W
1pcs
6000k/4000k/3000k
1100lm
AC100~277V
IP65
-30~50°C
>0.9
>50000H
<15%
50/60HZ
/
>70

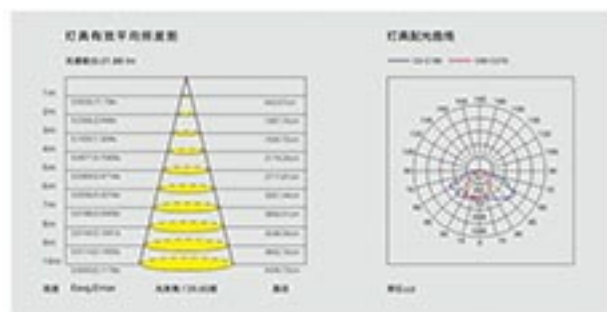
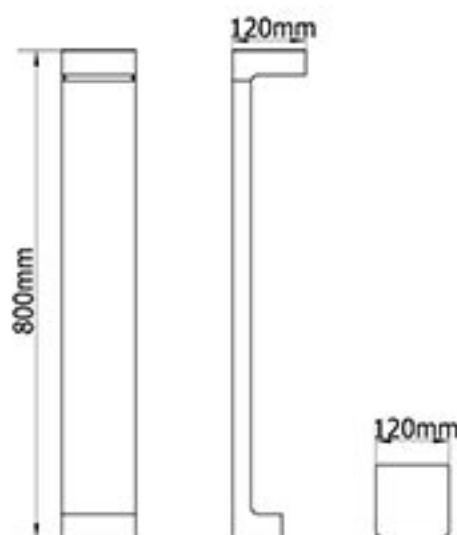

GENERAL PARAMETRES

常规参数

Rated power	额定功率
LED Quantity	LED数量
Color Temperature	色温
Luminous Flux	初始光通量
Input Voltage	输入电压
Protection Grade	防护等级
Operating Temperature	工作环境温度
Power Factor	功率因素
Life	使用寿命
THD	总谐波失真
Frequency Range	频率范围
Installation Pipe Diameter	安装管径
CRI	显色指数

10W
1pcs
6000k/4000k/3000k
1100lm
AC100~277V
IP65
-30~50℃
>0.9
>50000H
<15%
50/60HZ
/
>70

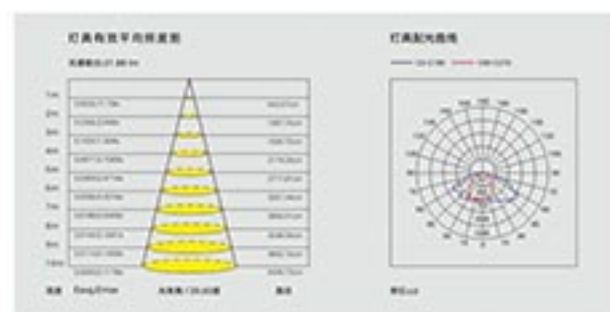
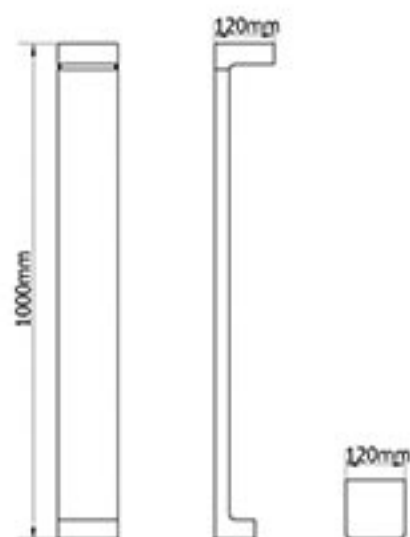
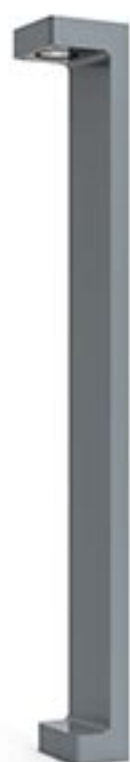

GENERAL PARAMETRES

常规参数

Rated power	额定功率
LED Quantity	LED数量
Color Temperature	色温
Luminous Flux	初始光通量
Input Voltage	输入电压
Protection Grade	防护等级
Operating Temperature	工作环境温度
Power Factor	功率因素
Life	使用寿命
THD	总谐波失真
Frequency Range	频率范围
Installation Pipe Diameter	安装管径
CRI	显色指数

10W
1pcs
6000k/4000k/3000k
1100lm
AC100~277V
IP65
-30~50°C
>0.9
>50000H
<15%
50/60HZ
/
>70

草坪灯 BOLLARD LIGHT

IP65 CCC CE



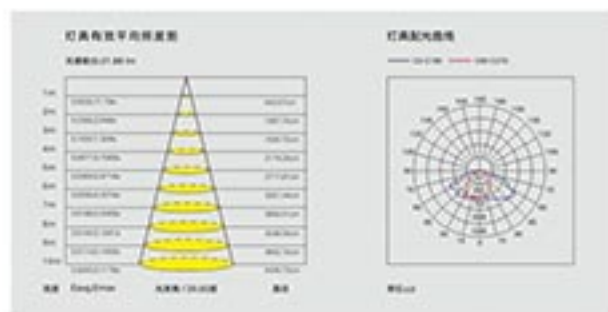
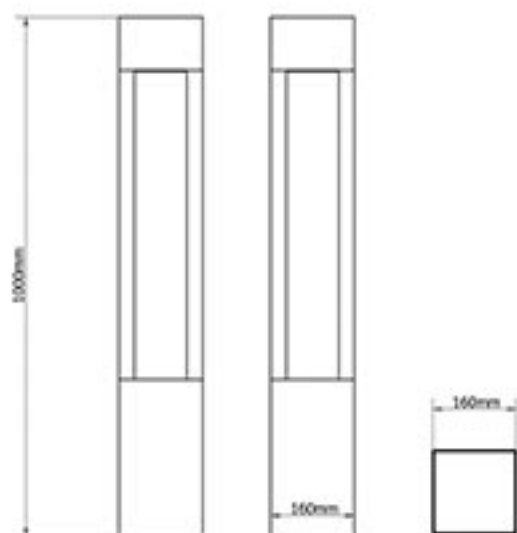

GENERAL PARAMETRES

常规参数

Rated power	额定功率
LED Quantity	LED数量
Color Temperature	色温
Luminous Flux	初始光通量
Input Voltage	输入电压
Protection Grade	防护等级
Operating Temperature	工作环境温度
Power Factor	功率因素
Life	使用寿命
THD	总谐波失真
Frequency Range	频率范围
Installation Pipe Diameter	安装管径
CRI	显色指数

20W
1pcs
6000k/4000k/3000k
2200lm
AC100~277V
IP65
-30~50°C
>0.9
>50000H
<15%
50/60HZ
/
>70

草坪灯 BOLLARD LIGHT

IP65 CCC CE

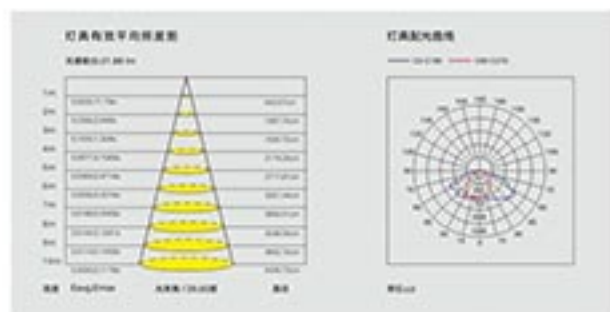
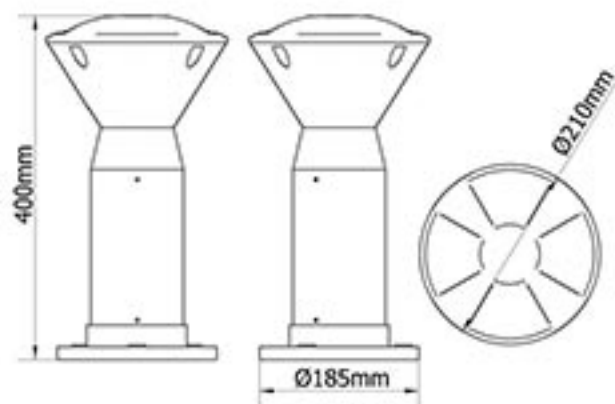

GENERAL PARAMETRES
常规参数

Rated power	额定功率
LED Quantity	LED数量
Color Temperature	色温
Luminous Flux	初始光通量
Input Voltage	输入电压
Protection Grade	防护等级
Operating Temperature	工作环境温度
Power Factor	功率因素
Life	使用寿命
THD	总谐波失真
Frequency Range	频率范围
Installation Pipe Diameter	安装管径
CRI	显色指数

10W
10pcs
6000k/4000k/3000k
1100lm
AC100~277V
IP65
-30~50°C
>0.9
>50000H
<15%
50/60HZ
/
>70

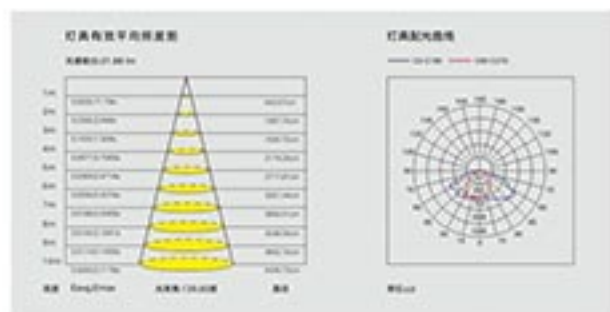
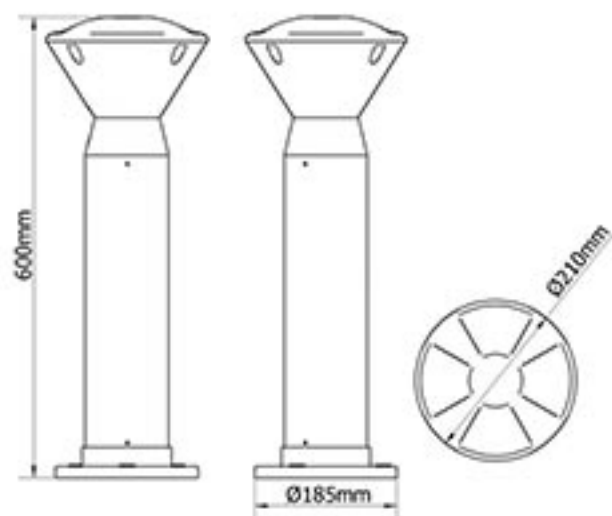
GENERAL PARAMETRES
常规参数

Rated power	额定功率
LED Quantity	LED数量
Color Temperature	色温
Luminous Flux	初始光通量
Input Voltage	输入电压
Protection Grade	防护等级
Operating Temperature	工作环境温度
Power Factor	功率因素
Life	使用寿命
THD	总谐波失真
Frequency Range	频率范围
Installation Pipe Diameter	安装管径
CRI	显色指数

10W
10pcs
6000k/4000k/3000k
1100lm
AC100~277V
IP65
-30~50°C
>0.9
>50000H
<15%
50/60HZ
/
>70

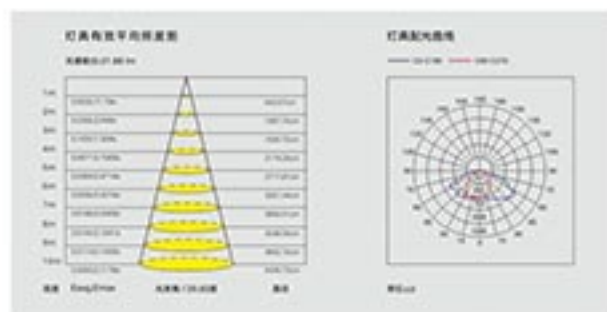
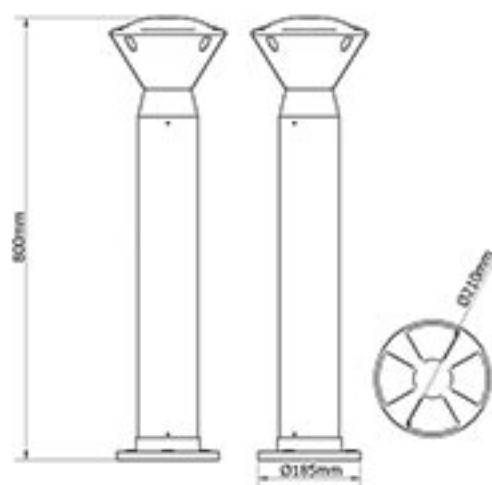
GENERAL PARAMETRES
常规参数

Rated power	额定功率
LED Quantity	LED数量
Color Temperature	色温
Luminous Flux	初始光通量
Input Voltage	输入电压
Protection Grade	防护等级
Operating Temperature	工作环境温度
Power Factor	功率因素
Life	使用寿命
THD	总谐波失真
Frequency Range	频率范围
Installation Pipe Diameter	安装管径
CRI	显色指数

10W
10pcs
6000k/4000k/3000k
1100lm
AC100~277V
IP65
-30~50°C
>0.9
>50000H
<15%
50/60HZ
/
>70

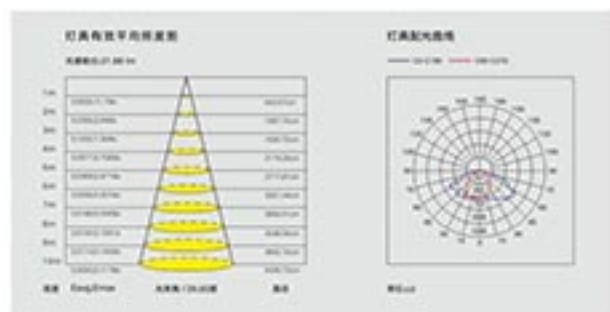
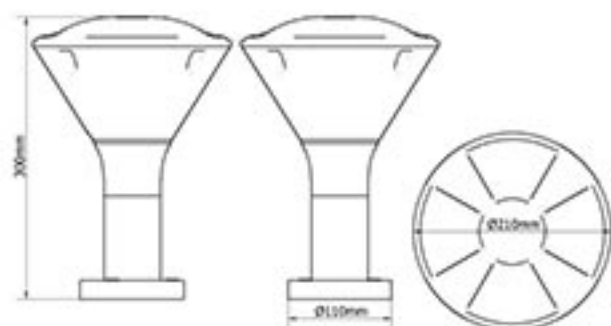

GENERAL PARAMETRES

常规参数

Rated power	额定功率
LED Quantity	LED数量
Color Temperature	色温
Luminous Flux	初始光通量
Input Voltage	输入电压
Protection Grade	防护等级
Operating Temperature	工作环境温度
Power Factor	功率因素
Life	使用寿命
THD	总谐波失真
Frequency Range	频率范围
Installation Pipe Diameter	安装管径
CRI	显色指数

10W
10pcs
6000k/4000k/3000k
1100lm
AC100~277V
IP65
-30~50°C
>0.9
>50000H
<15%
50/60HZ
/
>70

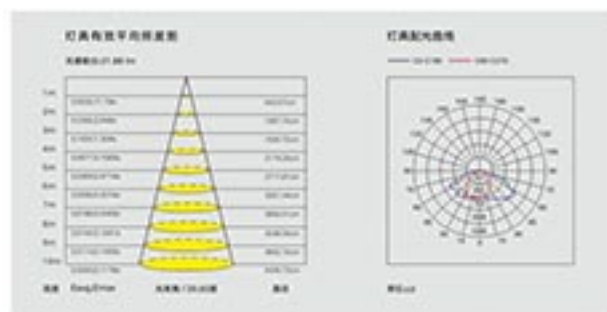
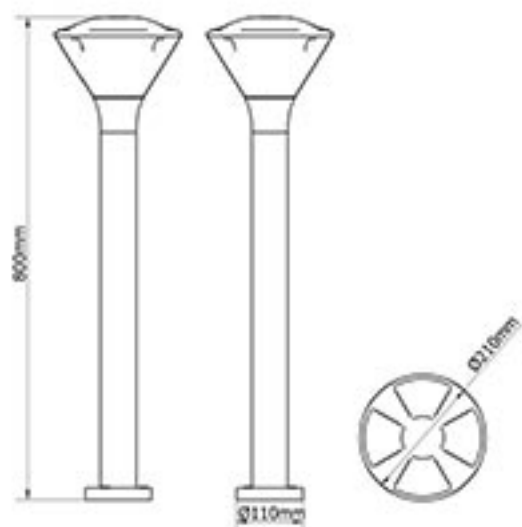

GENERAL PARAMETRES

常规参数

Rated power	额定功率
LED Quantity	LED数量
Color Temperature	色温
Luminous Flux	初始光通量
Input Voltage	输入电压
Protection Grade	防护等级
Operating Temperature	工作环境温度
Power Factor	功率因素
Life	使用寿命
THD	总谐波失真
Frequency Range	频率范围
Installation Pipe Diameter	安装管径
CRI	显色指数

10W
10pcs
6000k/4000k/3000k
1100lm
AC100~277V
IP65
-30~50°C
>0.9
>50000H
<15%
50/60HZ
/
>70

草坪灯 BOLLARD LIGHT

IP65 CCC CE

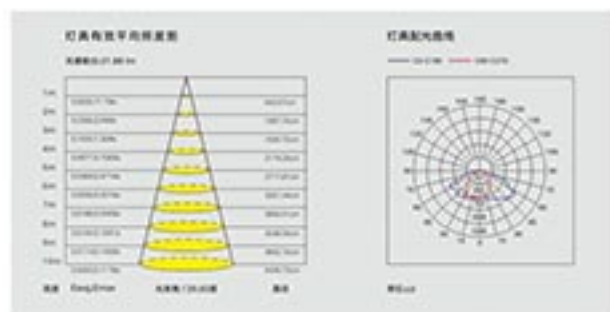
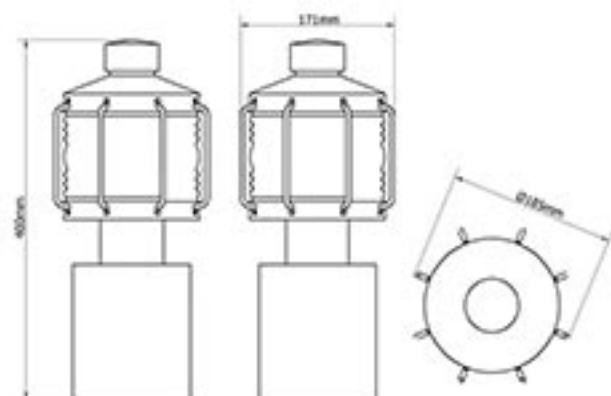

GENERAL PARAMETRES
常规参数

Rated power	额定功率
LED Quantity	LED数量
Color Temperature	色温
Luminous Flux	初始光通量
Input Voltage	输入电压
Protection Grade	防护等级
Operating Temperature	工作环境温度
Power Factor	功率因素
Life	使用寿命
THD	总谐波失真
Frequency Range	频率范围
Installation Pipe Diameter	安装管径
CRI	显色指数

10W
1pcs
6000k/4000k/3000k
1100lm
AC100~277V
IP65
-30~50°C
>0.9
>50000H
<15%
50/60HZ
/
>70

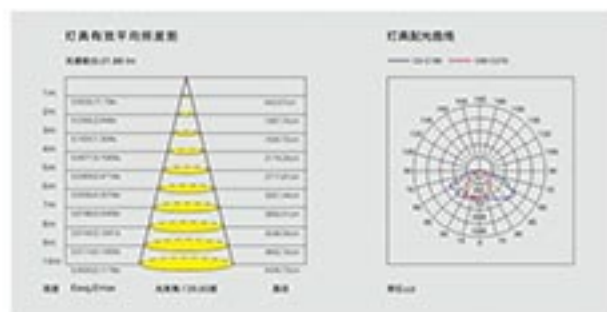
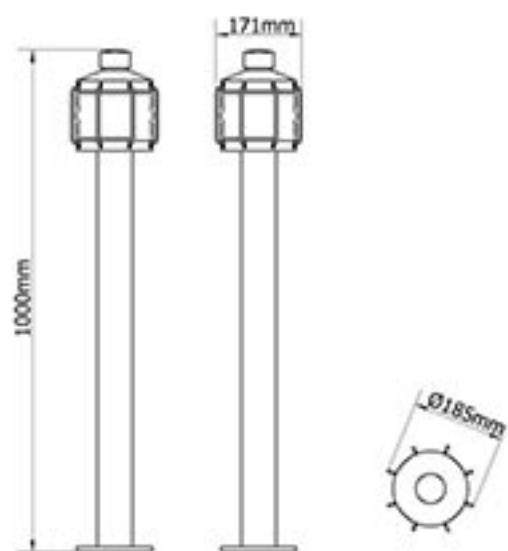
GENERAL PARAMETRES
常规参数

Rated power	额定功率
LED Quantity	LED数量
Color Temperature	色温
Luminous Flux	初始光通量
Input Voltage	输入电压
Protection Grade	防护等级
Operating Temperature	工作环境温度
Power Factor	功率因素
Life	使用寿命
THD	总谐波失真
Frequency Range	频率范围
Installation Pipe Diameter	安装管径
CRI	显色指数

10W
1pcs
6000k/4000k/3000k
1100lm
AC100~277V
IP65
-30~50°C
>0.9
>50000H
<15%
50/60HZ
/
>70

草坪灯 BOLLARD LIGHT

IP65  CE

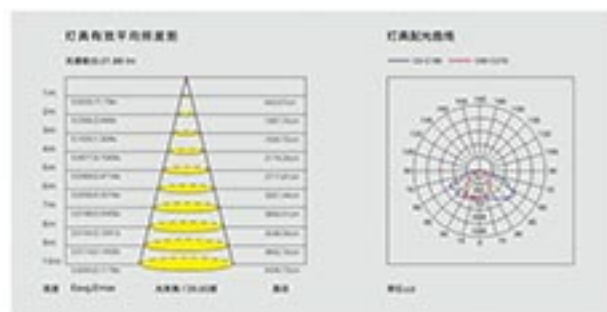
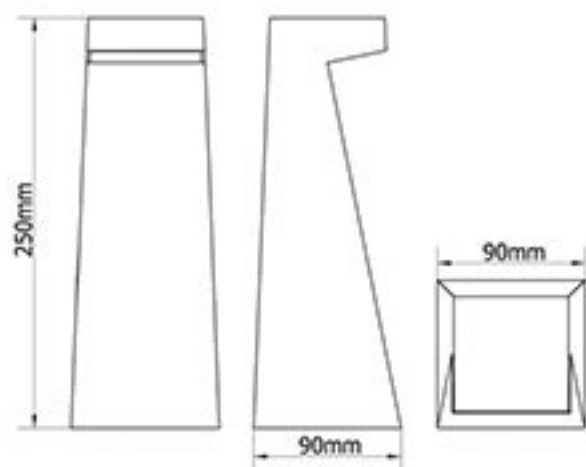
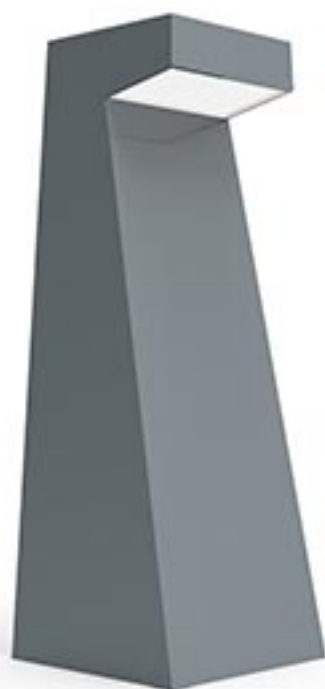

GENERAL PARAMETRES
常规参数

Rated power	额定功率
LED Quantity	LED数量
Color Temperature	色温
Luminous Flux	初始光通量
Input Voltage	输入电压
Protection Grade	防护等级
Operating Temperature	工作环境温度
Power Factor	功率因素
Life	使用寿命
THD	总谐波失真
Frequency Range	频率范围
Installation Pipe Diameter	安装管径
CRI	显色指数

10W
1pcs
6000k/4000k/3000k
1100lm
AC100~277V
IP65
-30~50°C
>0.9
>50000H
<15%
50/60HZ
/
>70

草坪灯 BOLLARD LIGHT

IP65 CCC CE



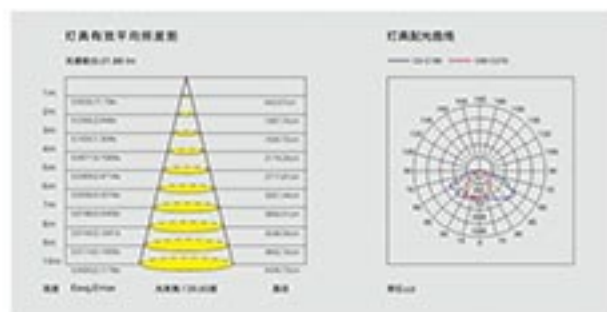
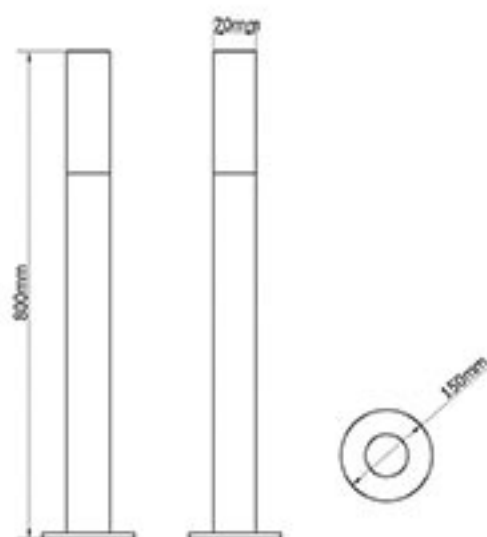

GENERAL PARAMETRES

常规参数

Rated power	额定功率
LED Quantity	LED数量
Color Temperature	色温
Luminous Flux	初始光通量
Input Voltage	输入电压
Protection Grade	防护等级
Operating Temperature	工作环境温度
Power Factor	功率因素
Life	使用寿命
THD	总谐波失真
Frequency Range	频率范围
Installation Pipe Diameter	安装管径
CRI	显色指数

10W
1pcs
6000k/4000k/3000k
1100lm
AC100-277V
IP65
-30-50°C
>0.9
>50000H
<15%
50/60HZ
/
>70



草坪灯 BOLLARD LIGHT

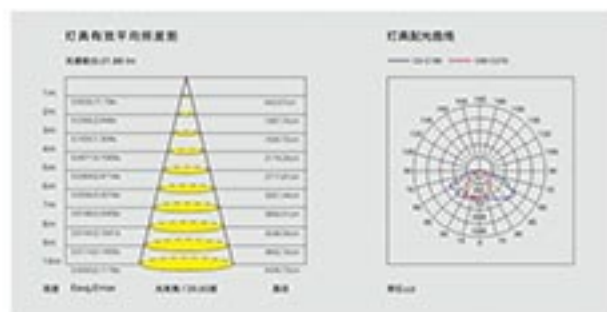
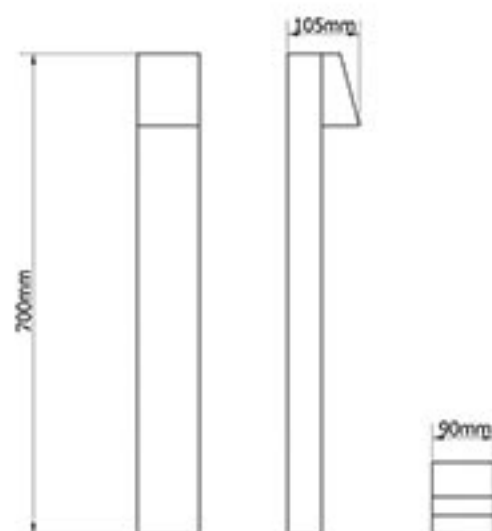
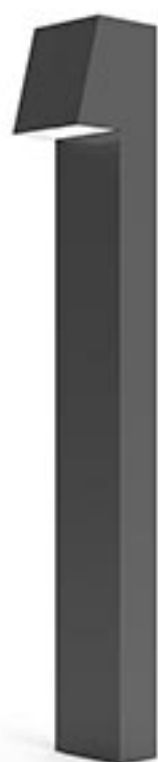

GENERAL PARAMETRES
常规参数

Rated power	额定功率
LED Quantity	LED数量
Color Temperature	色温
Luminous Flux	初始光通量
Input Voltage	输入电压
Protection Grade	防护等级
Operating Temperature	工作环境温度
Power Factor	功率因素
Life	使用寿命
THD	总谐波失真
Frequency Range	频率范围
Installation Pipe Diameter	安装管径
CRI	显色指数

6W
1pcs
6000k/4000k/3000k
660lm
AC100~277V
IP65
-30~50°C
>0.9
>50000H
<15%
50/60HZ
/
>70

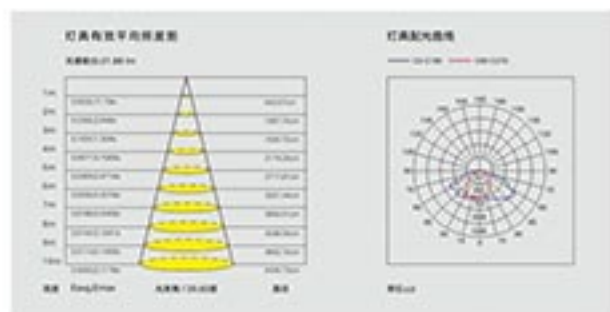
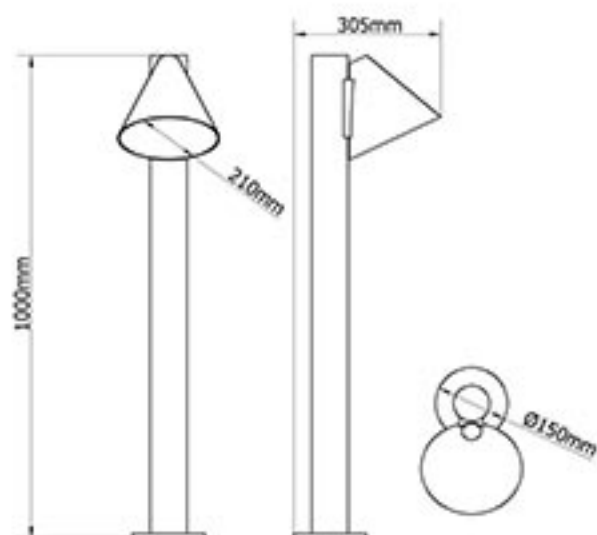

草坪灯 BOLLARD LIGHT

GENERAL PARAMETRES
常规参数

Rated power	额定功率
LED Quantity	LED数量
Color Temperature	色温
Luminous Flux	初始光通量
Input Voltage	输入电压
Protection Grade	防护等级
Operating Temperature	工作环境温度
Power Factor	功率因素
Life	使用寿命
THD	总谐波失真
Frequency Range	频率范围
Installation Pipe Diameter	安装管径
CRI	显色指数

10W
1pcs
6000k/4000k/3000k
1100lm
AC100~277V
IP65
-30~50°C
>0.9
>50000H
<15%
50/60HZ
/
>70

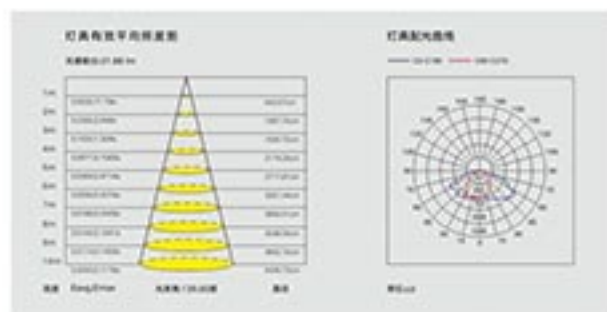
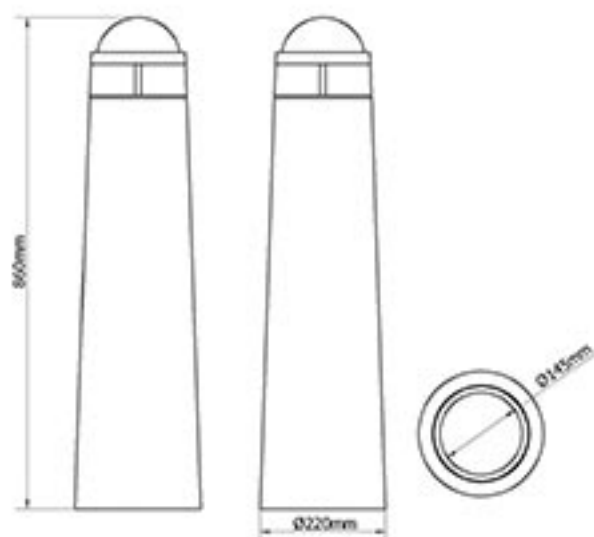

GENERAL PARAMETRES
常规参数

Rated power	额定功率
LED Quantity	LED数量
Color Temperature	色温
Luminous Flux	初始光通量
Input Voltage	输入电压
Protection Grade	防护等级
Operating Temperature	工作环境温度
Power Factor	功率因素
Life	使用寿命
THD	总谐波失真
Frequency Range	频率范围
Installation Pipe Diameter	安装管径
CRI	显色指数

10W
10pcs
6000k/4000k/3000k
1100lm
AC100~277V
IP65
-30~50°C
>0.9
>50000H
<15%
50/60HZ
/
>70

草坪灯 BOLLARD LIGHT

IP65 CE CE



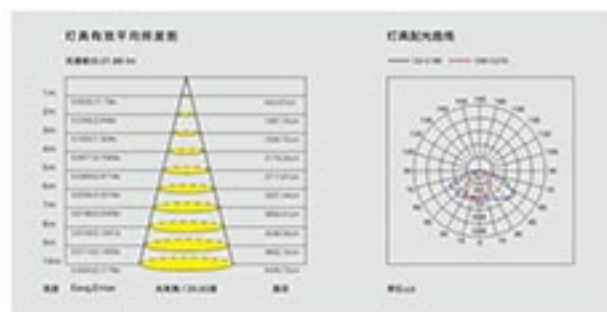
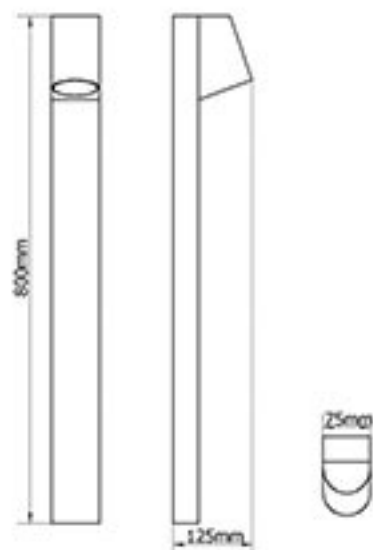

GENERAL PARAMETRES

常规参数

Rated power	额定功率
LED Quantity	LED数量
Color Temperature	色温
Luminous Flux	初始光通量
Input Voltage	输入电压
Protection Grade	防护等级
Operating Temperature	工作环境温度
Power Factor	功率因素
Life	使用寿命
THD	总谐波失真
Frequency Range	频率范围
Installation Pipe Diameter	安装管径
CRI	显色指数

6W
1pcs
6000k/4000k/3000k
660lm
AC100~277V
IP65
-30~50°C
>0.9
>50000H
<15%
50/60HZ
/
>70



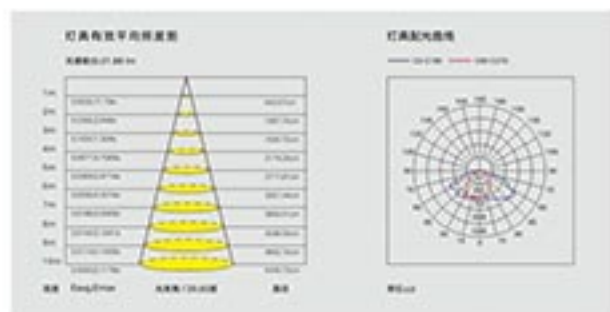
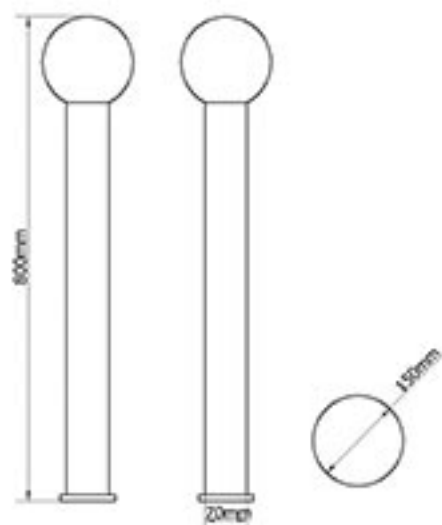

GENERAL PARAMETRES

常规参数

Rated power	额定功率
LED Quantity	LED数量
Color Temperature	色温
Luminous Flux	初始光通量
Input Voltage	输入电压
Protection Grade	防护等级
Operating Temperature	工作环境温度
Power Factor	功率因素
Life	使用寿命
THD	总谐波失真
Frequency Range	频率范围
Installation Pipe Diameter	安装管径
CRI	显色指数

10W
1pcs
6000k/4000k/3000k
1100lm
AC100~277V
IP65
-30~50°C
>0.9
>50000H
<15%
50/60HZ
/
>70

草坪灯 BOLLARD LIGHT

IP65 3000K



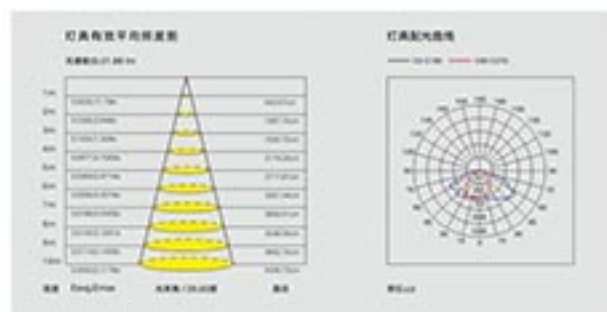
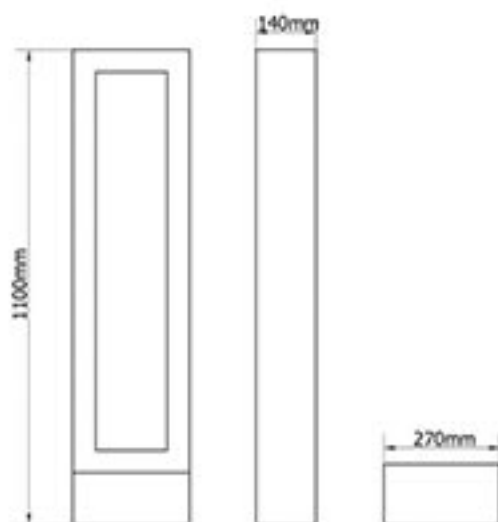
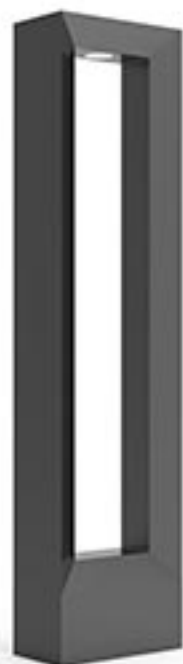

GENERAL PARAMETRES

常规参数

Rated power	额定功率
LED Quantity	LED数量
Color Temperature	色温
Luminous Flux	初始光通量
Input Voltage	输入电压
Protection Grade	防护等级
Operating Temperature	工作环境温度
Power Factor	功率因素
Life	使用寿命
THD	总谐波失真
Frequency Range	频率范围
Installation Pipe Diameter	安装管径
CRI	显色指数

10W
1pcs
6000k/4000k/3000k
1100lm
AC100~277V
IP65
-30~50°C
>0.9
>50000H
<15%
50/60HZ
/
>70



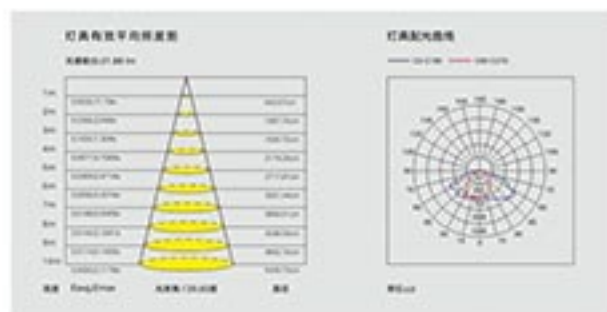
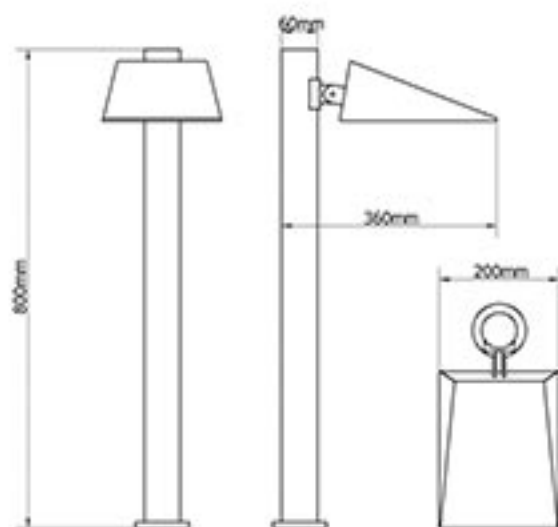

GENERAL PARAMETRES

常规参数

Rated power	额定功率
LED Quantity	LED数量
Color Temperature	色温
Luminous Flux	初始光通量
Input Voltage	输入电压
Protection Grade	防护等级
Operating Temperature	工作环境温度
Power Factor	功率因素
Life	使用寿命
THD	总谐波失真
Frequency Range	频率范围
Installation Pipe Diameter	安装管径
CRI	显色指数

10W
10pcs
6000k/4000k/3000k
1100lm
AC100~277V
IP65
-30~50°C
>0.9
>50000H
<15%
50/60HZ
/
>70



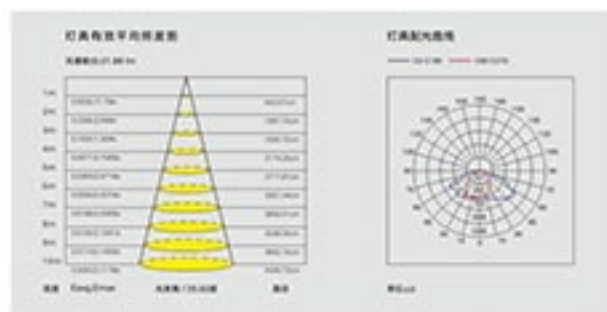
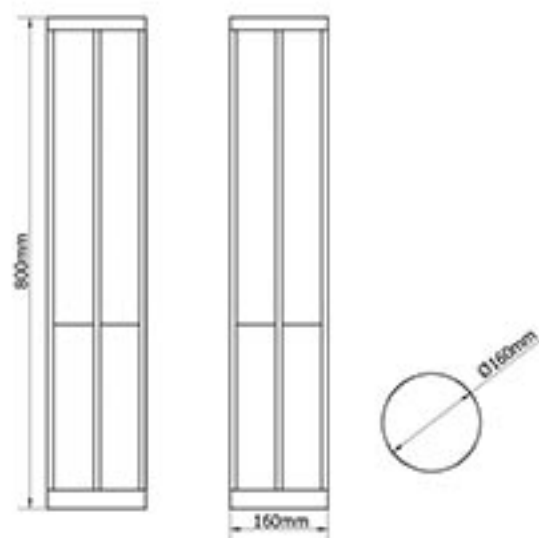

GENERAL PARAMETRES

常规参数

Rated power	额定功率
LED Quantity	LED数量
Color Temperature	色温
Luminous Flux	初始光通量
Input Voltage	输入电压
Protection Grade	防护等级
Operating Temperature	工作环境温度
Power Factor	功率因素
Life	使用寿命
THD	总谐波失真
Frequency Range	频率范围
Installation Pipe Diameter	安装管径
CRI	显色指数

10W
1pcs
6000k/4000k/3000k
1100lm
AC100~277V
IP65
-30~50°C
>0.9
>50000H
<15%
50/60HZ
/
>70



草坪灯 BOLLARD LIGHT

IP65 CCC CE

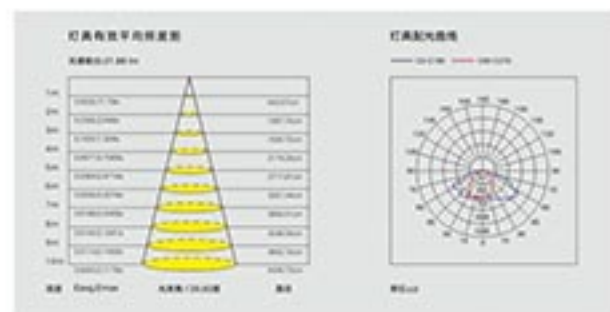
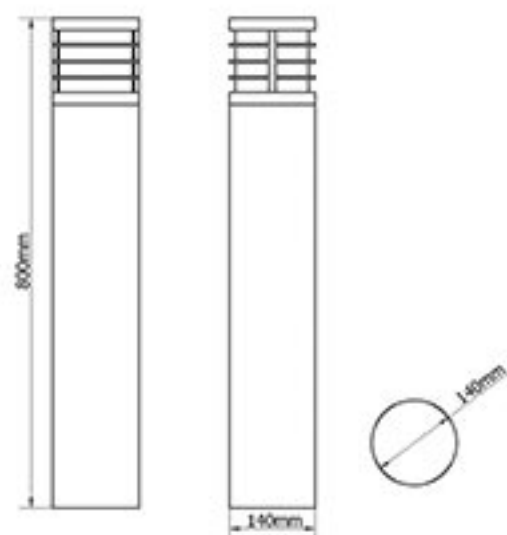

GENERAL PARAMETRES

常规参数

Rated power	额定功率
LED Quantity	LED数量
Color Temperature	色温
Luminous Flux	初始光通量
Input Voltage	输入电压
Protection Grade	防护等级
Operating Temperature	工作环境温度
Power Factor	功率因素
Life	使用寿命
THD	总谐波失真
Frequency Range	频率范围
Installation Pipe Diameter	安装管径
CRI	显色指数

10W
1pcs
6000k/4000k/3000k
1100lm
AC100~277V
IP65
-30~50°C
>0.9
>50000H
<15%
50/60HZ
/
>70



草坪灯 BOLLARD LIGHT

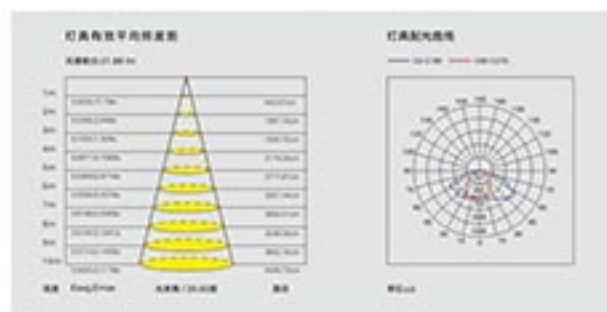
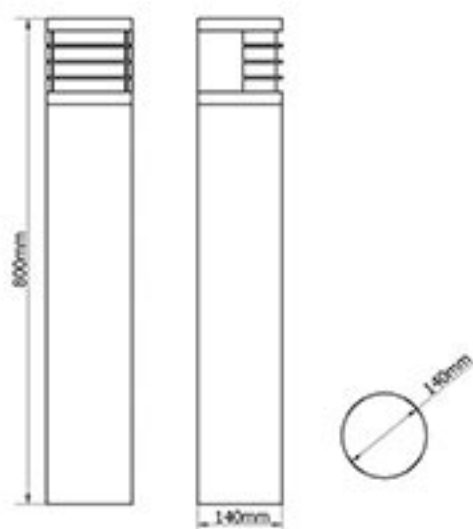

GENERAL PARAMETRES

常规参数

Rated power	额定功率
LED Quantity	LED数量
Color Temperature	色温
Luminous Flux	初始光通量
Input Voltage	输入电压
Protection Grade	防护等级
Operating Temperature	工作环境温度
Power Factor	功率因素
Life	使用寿命
THD	总谐波失真
Frequency Range	频率范围
Installation Pipe Diameter	安装管径
CRI	显色指数

10W
1pcs
6000k/4000k/3000k
1100lm
AC100~277V
IP65
-30~50°C
>0.9
>50000H
<15%
50/60HZ
/
>70

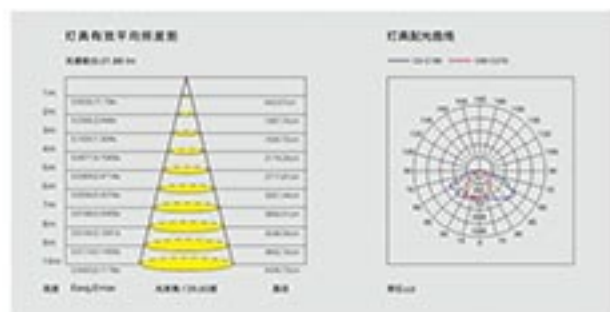
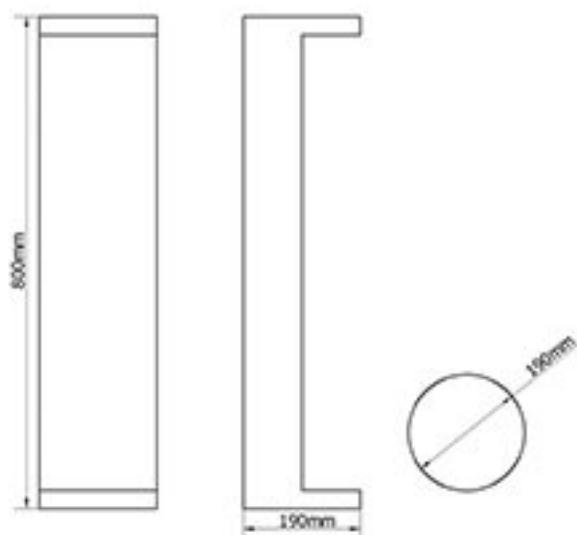

GENERAL PARAMETRES

常规参数

Rated power	额定功率
LED Quantity	LED数量
Color Temperature	色温
Luminous Flux	初始光通量
Input Voltage	输入电压
Protection Grade	防护等级
Operating Temperature	工作环境温度
Power Factor	功率因素
Life	使用寿命
THD	总谐波失真
Frequency Range	频率范围
Installation Pipe Diameter	安装管径
CRI	显色指数

10W
1pcs
6000k/4000k/3000k
1100lm
AC100-277V
IP65
-30-50°C
>0.9
>50000H
<15%
50/60HZ
/
>70



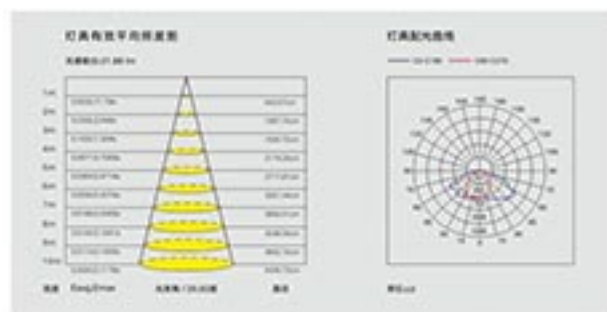
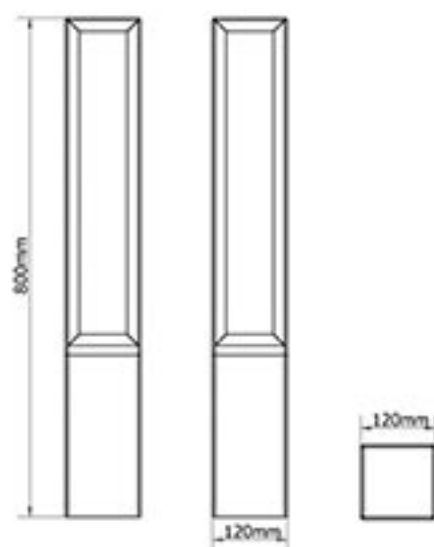

GENERAL PARAMETRES
常规参数

Rated power	额定功率
LED Quantity	LED数量
Color Temperature	色温
Luminous Flux	初始光通量
Input Voltage	输入电压
Protection Grade	防护等级
Operating Temperature	工作环境温度
Power Factor	功率因素
Life	使用寿命
THD	总谐波失真
Frequency Range	频率范围
Installation Pipe Diameter	安装管径
CRI	显色指数

10W
1pcs
6000k/4000k/3000k
1100lm
AC100~277V
IP65
-30~50°C
>0.9
>50000H
<15%
50/60HZ
/
>70

草坪灯 BOLLARD LIGHT

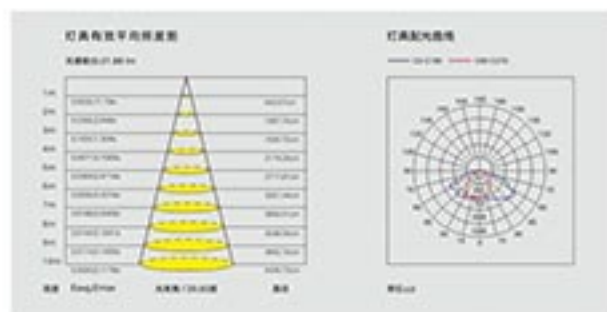
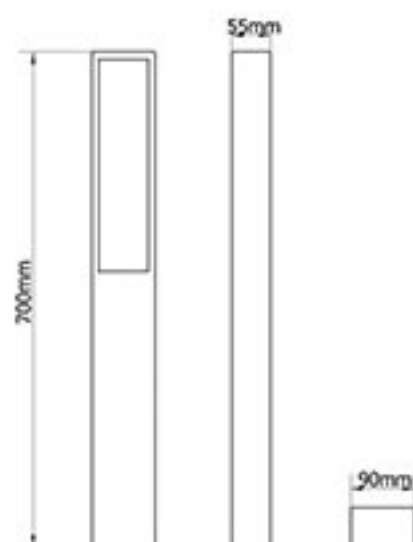
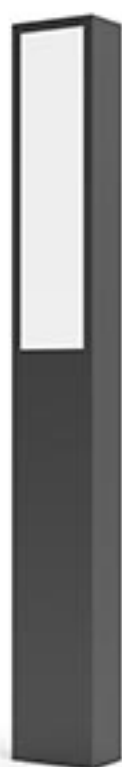



GENERAL PARAMETRES

常规参数

Rated power	额定功率
LED Quantity	LED数量
Color Temperature	色温
Luminous Flux	初始光通量
Input Voltage	输入电压
Protection Grade	防护等级
Operating Temperature	工作环境温度
Power Factor	功率因素
Life	使用寿命
THD	总谐波失真
Frequency Range	频率范围
Installation Pipe Diameter	安装管径
CRI	显色指数

10W
10pcs
6000k/4000k/3000k
1100lm
AC100~277V
IP65
-30~50°C
>0.9
>50000H
<15%
50/60HZ
/
>70

草坪灯 BOLLARD LIGHT

IP65 CCC CE

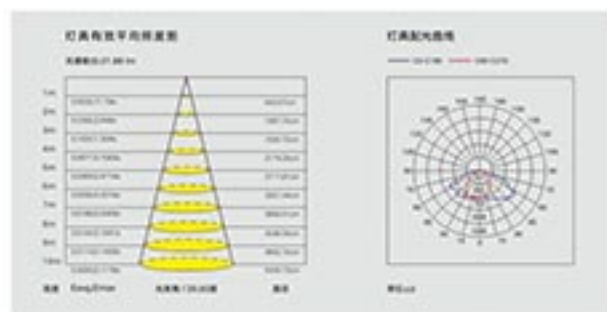
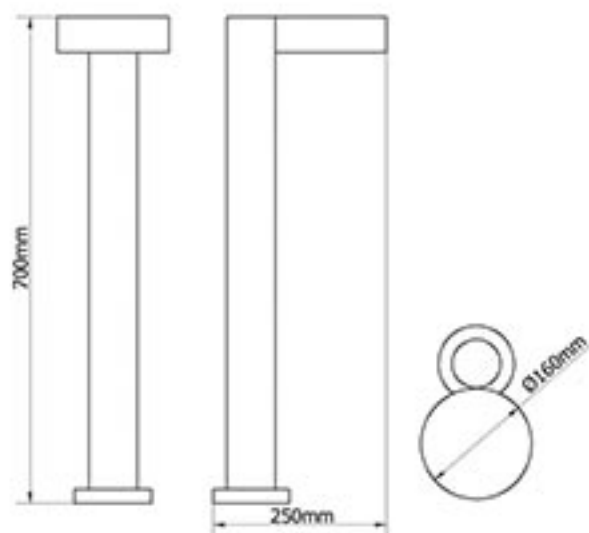

GENERAL PARAMETRES
常规参数

Rated power	额定功率
LED Quantity	LED数量
Color Temperature	色温
Luminous Flux	初始光通量
Input Voltage	输入电压
Protection Grade	防护等级
Operating Temperature	工作环境温度
Power Factor	功率因素
Life	使用寿命
THD	总谐波失真
Frequency Range	频率范围
Installation Pipe Diameter	安装管径
CRI	显色指数

10W
1pcs
6000k/4000k/3000k
1100lm
AC100~277V
IP65
-30~50°C
>0.9
>50000H
<15%
50/60HZ
/
>70



草坪灯 BOLLARD LIGHT

IP65

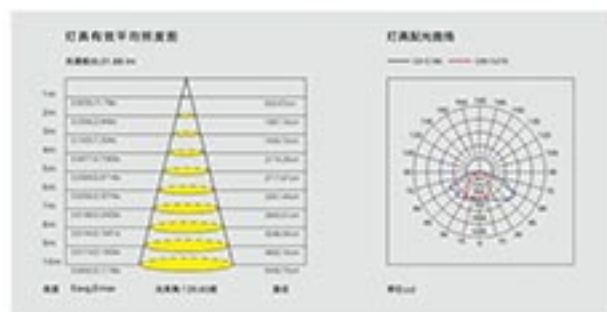
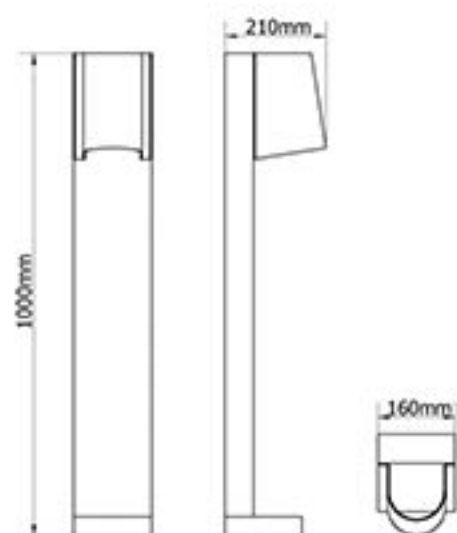

GENERAL PARAMETRES

常规参数

Rated power	额定功率
LED Quantity	LED数量
Color Temperature	色温
Luminous Flux	初始光通量
Input Voltage	输入电压
Protection Grade	防护等级
Operating Temperature	工作环境温度
Power Factor	功率因素
Life	使用寿命
THD	总谐波失真
Frequency Range	频率范围
Installation Pipe Diameter	安装管径
CRI	显色指数

10W
1pcs
6000k/4000k/3000k
1100lm
AC100~277V
IP65
-30~50°C
>0.9
>50000H
<15%
50/60HZ
/
>70

草坪灯 BOLLARD LIGHT

IP65 CCC CE



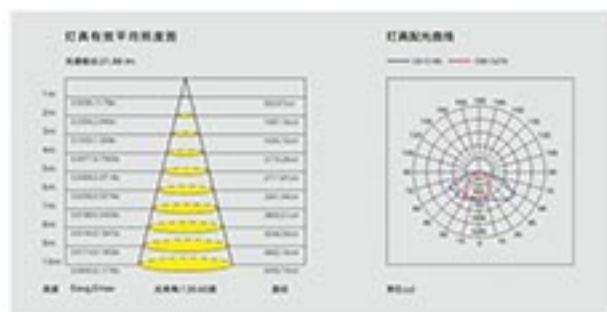
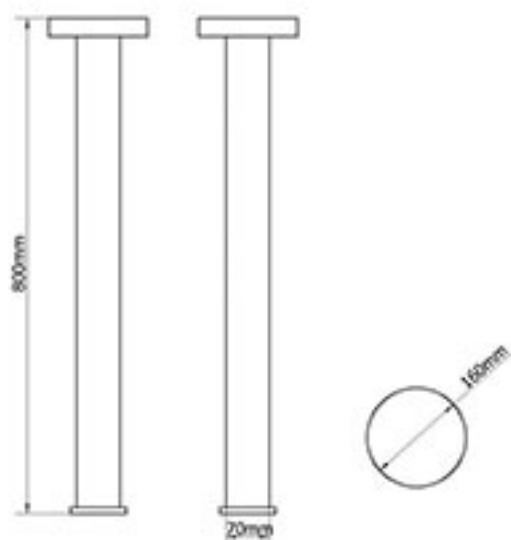

GENERAL PARAMETRES

常规参数

Rated power	额定功率
LED Quantity	LED数量
Color Temperature	色温
Luminous Flux	初始光通量
Input Voltage	输入电压
Protection Grade	防护等级
Operating Temperature	工作环境温度
Power Factor	功率因素
Life	使用寿命
THD	总谐波失真
Frequency Range	频率范围
Installation Pipe Diameter	安装管径
CRI	显色指数

6W
6pcs
6000k/4000k/3000k
660lm
AC100-277V
IP65
-30-50°C
>0.9
>50000H
<15%
50/60HZ
/
>70



草坪灯 BOLLARD LIGHT

IP65 CCC CE

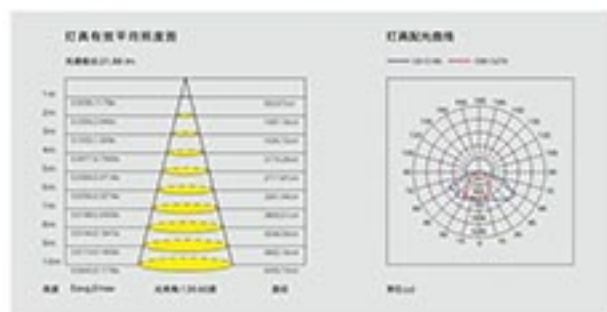
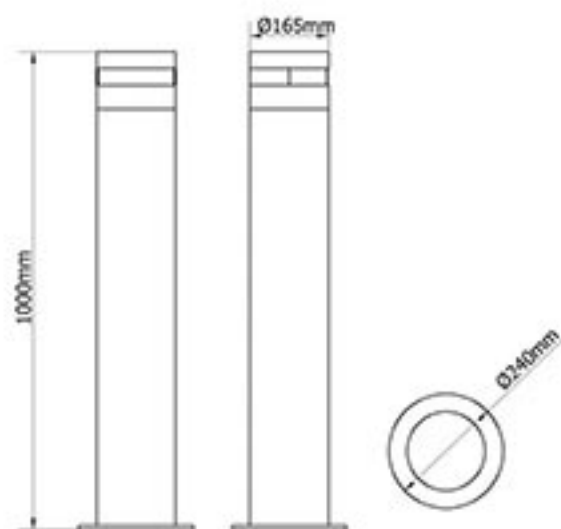

GENERAL PARAMETRES
常规参数

Rated power	额定功率
LED Quantity	LED数量
Color Temperature	色温
Luminous Flux	初始光通量
Input Voltage	输入电压
Protection Grade	防护等级
Operating Temperature	工作环境温度
Power Factor	功率因素
Life	使用寿命
THD	总谐波失真
Frequency Range	频率范围
Installation Pipe Diameter	安装管径
CRI	显色指数

10W
10pcs
6000k/4000k/3000k
1100lm
AC100~277V
IP65
-30~50°C
>0.9
>50000H
<15%
50/60HZ
/
>70

草坪灯 BOLLARD LIGHT

IP65 CCC CE



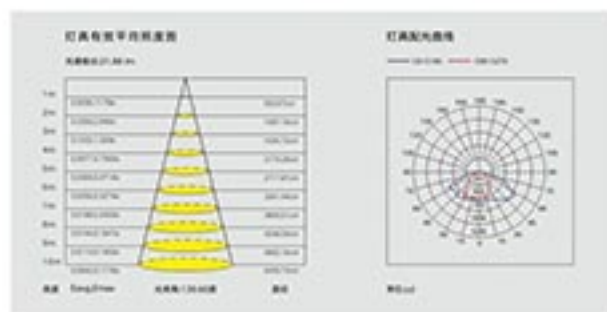
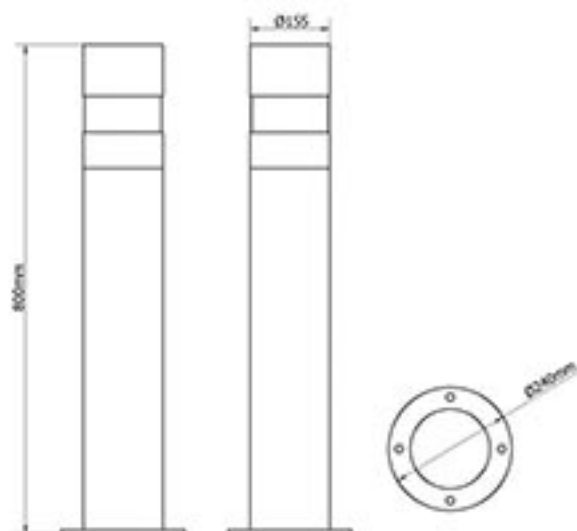

GENERAL PARAMETRES

常规参数

Rated power	额定功率
LED Quantity	LED数量
Color Temperature	色温
Luminous Flux	初始光通量
Input Voltage	输入电压
Protection Grade	防护等级
Operating Temperature	工作环境温度
Power Factor	功率因素
Life	使用寿命
THD	总谐波失真
Frequency Range	频率范围
Installation Pipe Diameter	安装管径
CRI	显色指数

10W
10pcs
6000k/4000k/3000k
1100lm
AC100~277V
IP65
-30~50°C
>0.9
>50000H
<15%
50/60HZ
/
>70

草坪灯 BOLLARD LIGHT

IP65 CCC CE



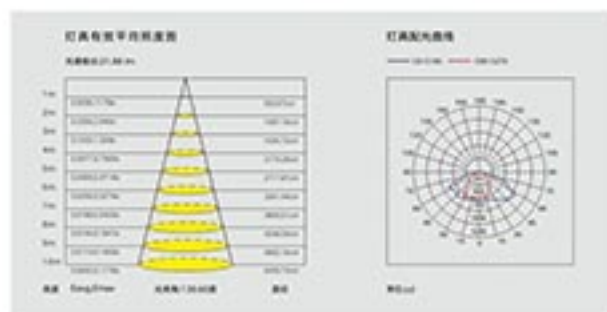
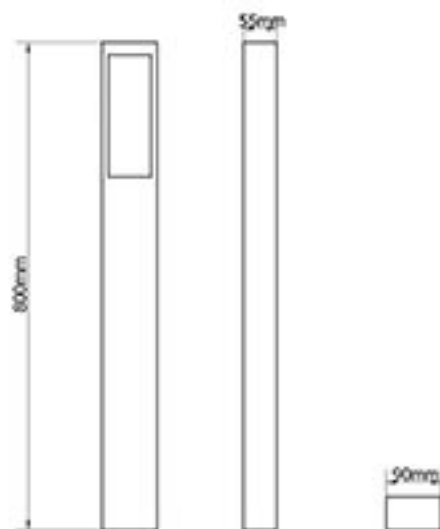

GENERAL PARAMETRES

常规参数

Rated power	额定功率
LED Quantity	LED数量
Color Temperature	色温
Luminous Flux	初始光通量
Input Voltage	输入电压
Protection Grade	防护等级
Operating Temperature	工作环境温度
Power Factor	功率因素
Life	使用寿命
THD	总谐波失真
Frequency Range	频率范围
Installation Pipe Diameter	安装管径
CRI	显色指数

10W
1pcs
6000k/4000k/3000k
1100lm
AC100~277V
IP65
-30~50°C
>0.9
>50000H
<15%
50/60HZ
/
>70



草坪灯 BOLLARD LIGHT

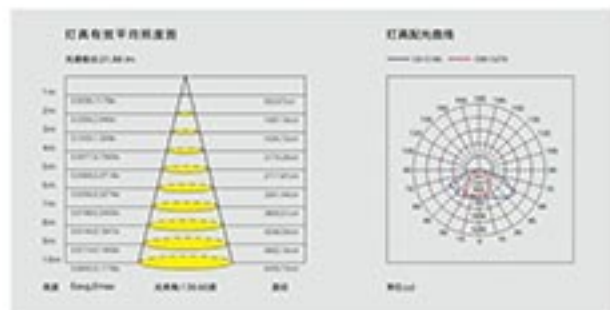
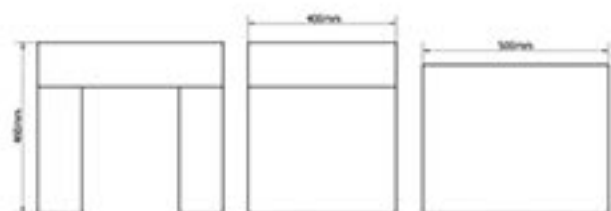

GENERAL PARAMETRES

常规参数

Rated power	额定功率
LED Quantity	LED数量
Color Temperature	色温
Luminous Flux	初始光通量
Input Voltage	输入电压
Protection Grade	防护等级
Operating Temperature	工作环境温度
Power Factor	功率因素
Life	使用寿命
THD	总谐波失真
Frequency Range	频率范围
Installation Pipe Diameter	安装管径
CRI	显色指数

10W
10pcs
6000k/4000k/3000k
1100lm
AC100~277V
IP65
-30~50°C
>0.9
>50000H
<15%
50/60HZ
/
>70

草坪灯 BOLLARD LIGHT

IP65 CCC CE



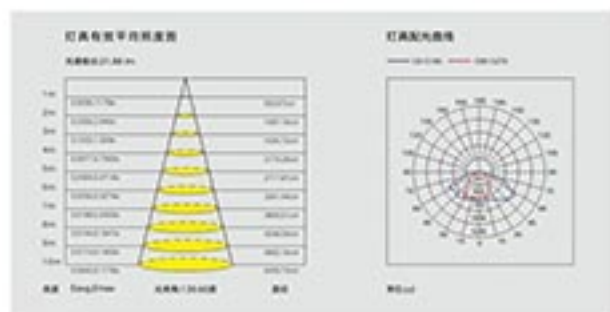
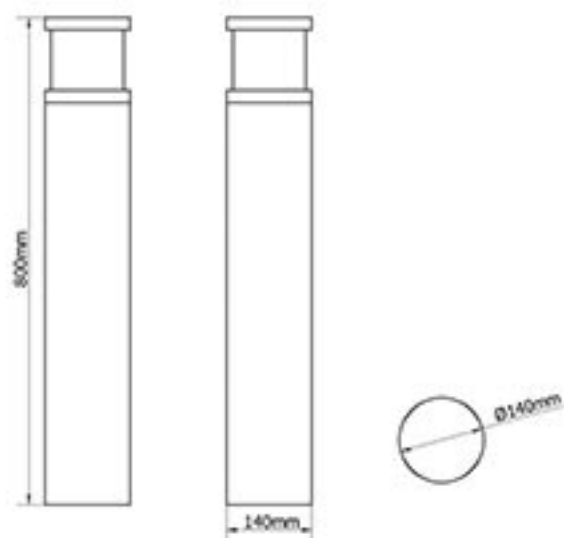

GENERAL PARAMETRES

常规参数

Rated power	额定功率
LED Quantity	LED数量
Color Temperature	色温
Luminous Flux	初始光通量
Input Voltage	输入电压
Protection Grade	防护等级
Operating Temperature	工作环境温度
Power Factor	功率因素
Life	使用寿命
THD	总谐波失真
Frequency Range	频率范围
Installation Pipe Diameter	安装管径
CRI	显色指数

10W
1pcs
6000k/4000k/3000k
1100lm
AC100~277V
IP65
-30~50°C
>0.9
>50000H
<15%
50/60HZ
/
>70

D 8034a

草坪灯 BOLLARD LIGHT

IP65 CCC CE



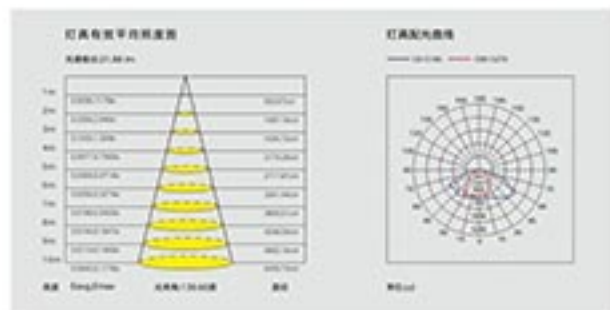
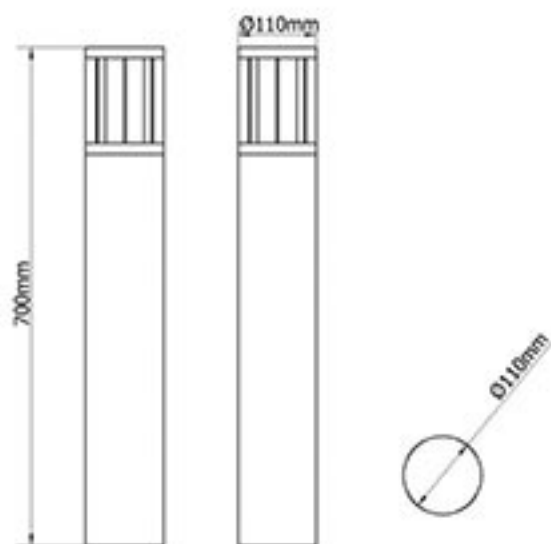

GENERAL PARAMETRES

常规参数

Rated power	额定功率
LED Quantity	LED数量
Color Temperature	色温
Luminous Flux	初始光通量
Input Voltage	输入电压
Protection Grade	防护等级
Operating Temperature	工作环境温度
Power Factor	功率因素
Life	使用寿命
THD	总谐波失真
Frequency Range	频率范围
Installation Pipe Diameter	安装管径
CRI	显色指数

10W
1pcs
6000k/4000k/3000k
1100lm
AC100~277V
IP65
-30~50°C
>0.9
>50000H
<15%
50/60HZ
/
>70



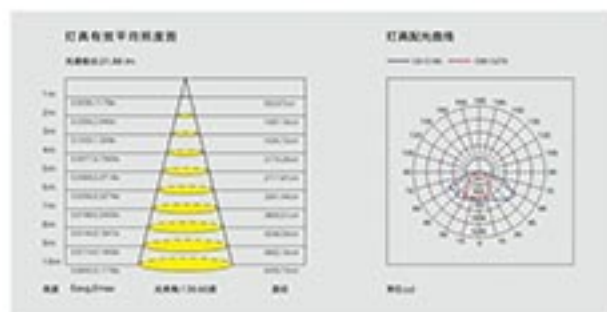
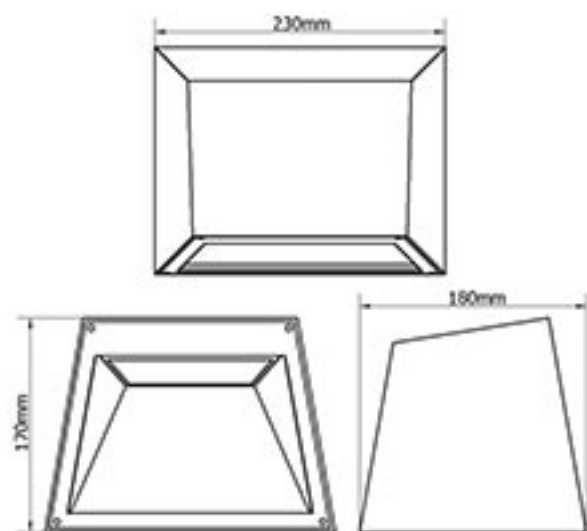

GENERAL PARAMETRES

常规参数

Rated power	额定功率
LED Quantity	LED数量
Color Temperature	色温
Luminous Flux	初始光通量
Input Voltage	输入电压
Protection Grade	防护等级
Operating Temperature	工作环境温度
Power Factor	功率因素
Life	使用寿命
THD	总谐波失真
Frequency Range	频率范围
Installation Pipe Diameter	安装管径
CRI	显色指数

Rated power	10W
LED Quantity	10pcs
Color Temperature	6000k/4000k/3000k
Luminous Flux	1100lm
Input Voltage	AC100~277V
Protection Grade	IP65
Operating Temperature	-30~50°C
Power Factor	>0.9
Life	>50000H
THD	<15%
Frequency Range	50/60HZ
Installation Pipe Diameter	/
CRI	>70



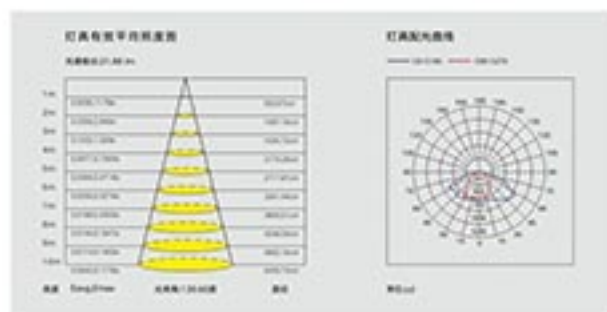
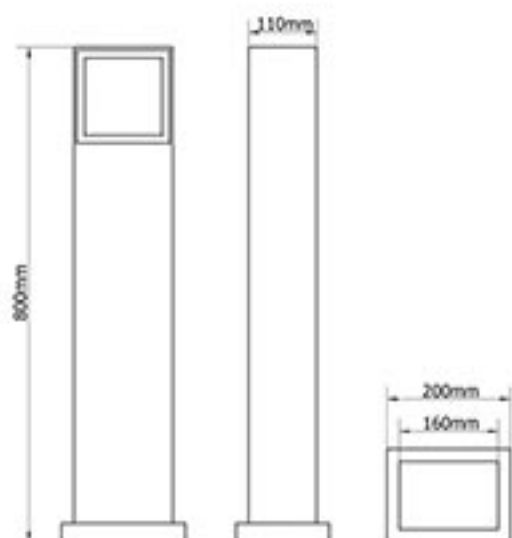
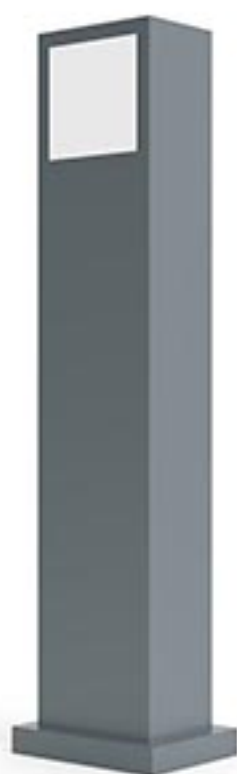

GENERAL PARAMETRES

常规参数

Rated power	额定功率
LED Quantity	LED数量
Color Temperature	色温
Luminous Flux	初始光通量
Input Voltage	输入电压
Protection Grade	防护等级
Operating Temperature	工作环境温度
Power Factor	功率因素
Life	使用寿命
THD	总谐波失真
Frequency Range	频率范围
Installation Pipe Diameter	安装管径
CRI	显色指数

10W
10pcs
6000k/4000k/3000k
1100lm
AC100-277V
IP65
-30-50°C
>0.9
>50000H
<15%
50/60HZ
/
>70



草坪灯 BOLLARD LIGHT

IP65 CCC CE

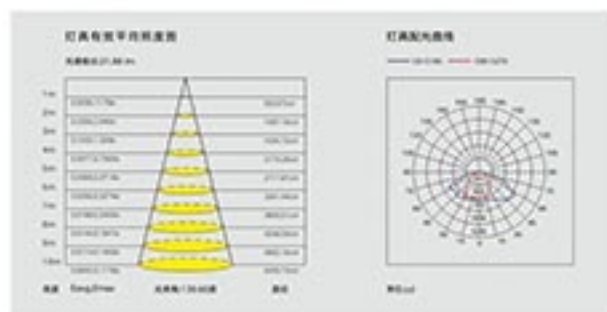
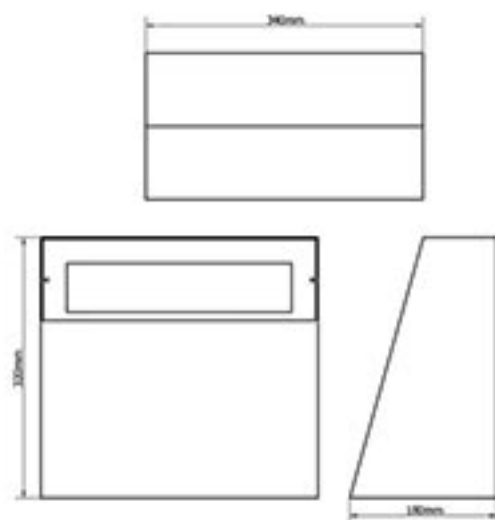

GENERAL PARAMETRES

常规参数

Rated power	额定功率
LED Quantity	LED数量
Color Temperature	色温
Luminous Flux	初始光通量
Input Voltage	输入电压
Protection Grade	防护等级
Operating Temperature	工作环境温度
Power Factor	功率因素
Life	使用寿命
THD	总谐波失真
Frequency Range	频率范围
Installation Pipe Diameter	安装管径
CRI	显色指数

10W
10pcs
6000k/4000k/3000k
1100lm
AC100~277V
IP65
-30~50°C
>0.9
>50000H
<15%
50/60HZ
/
>70



草坪灯 BOLLARD LIGHT

IP65 3000K



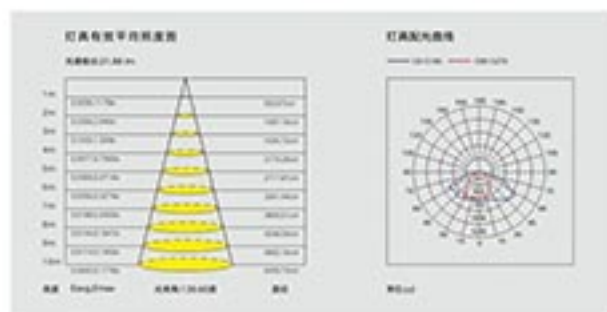
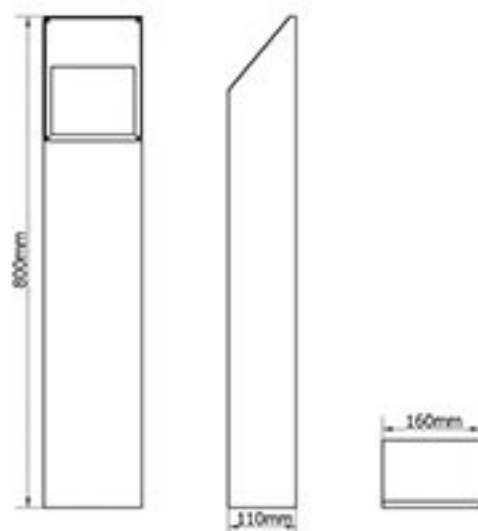

GENERAL PARAMETRES

常规参数

Rated power	额定功率
LED Quantity	LED数量
Color Temperature	色温
Luminous Flux	初始光通量
Input Voltage	输入电压
Protection Grade	防护等级
Operating Temperature	工作环境温度
Power Factor	功率因素
Life	使用寿命
THD	总谐波失真
Frequency Range	频率范围
Installation Pipe Diameter	安装管径
CRI	显色指数

10W
10pcs
6000k/4000k/3000k
1100lm
AC100~277V
IP65
-30~50°C
>0.9
>50000H
<15%
50/60HZ
/
>70

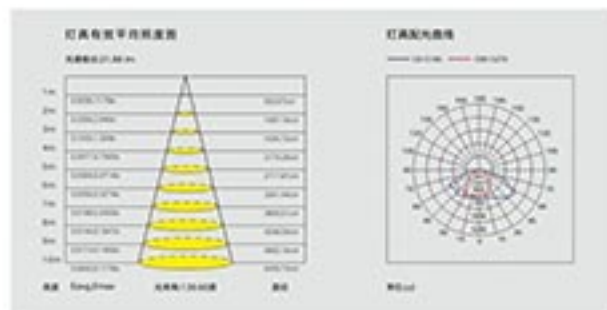
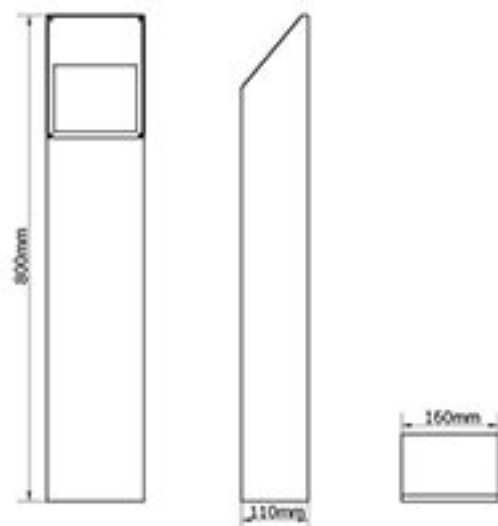

GENERAL PARAMETRES

常规参数

Rated power	额定功率
LED Quantity	LED数量
Color Temperature	色温
Luminous Flux	初始光通量
Input Voltage	输入电压
Protection Grade	防护等级
Operating Temperature	工作环境温度
Power Factor	功率因素
Life	使用寿命
THD	总谐波失真
Frequency Range	频率范围
Installation Pipe Diameter	安装管径
CRI	显色指数

10W
10pcs
6000k/4000k/3000k
1100lm
AC100~277V
IP65
-30~50°C
>0.9
>50000H
<15%
50/60HZ
/
>70



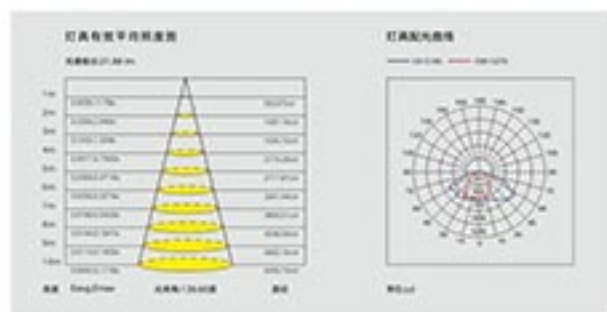
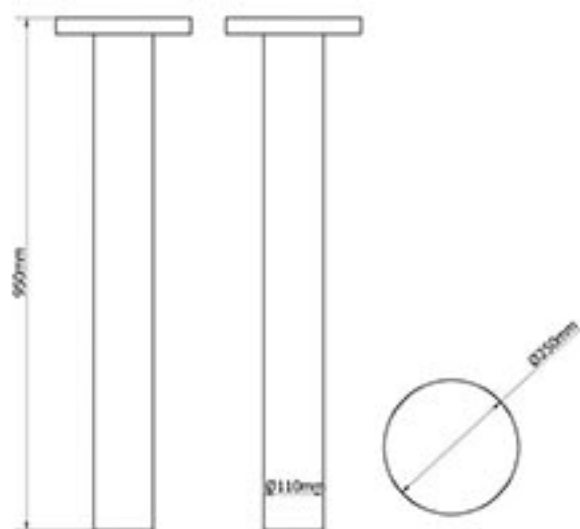

GENERAL PARAMETRES

常规参数

Rated power	额定功率
LED Quantity	LED数量
Color Temperature	色温
Luminous Flux	初始光通量
Input Voltage	输入电压
Protection Grade	防护等级
Operating Temperature	工作环境温度
Power Factor	功率因素
Life	使用寿命
THD	总谐波失真
Frequency Range	频率范围
Installation Pipe Diameter	安装管径
CRI	显色指数

10W
10pcs
6000k/4000k/3000k
1100lm
AC100~277V
IP65
-30~50°C
>0.9
>50000H
<15%
50/60HZ
/
>70

草坪灯 BOLLARD LIGHT

IP65 CCC CE

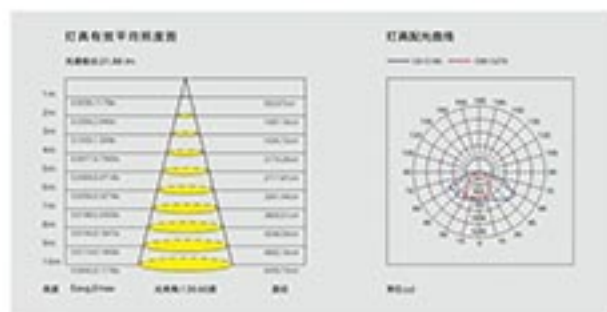
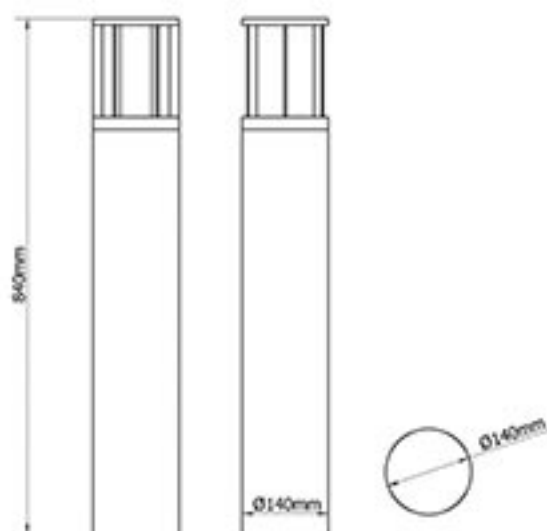

因为用心 自有不同

GENERAL PARAMETRES
常规参数

Rated power	额定功率
LED Quantity	LED数量
Color Temperature	色温
Luminous Flux	初始光通量
Input Voltage	输入电压
Protection Grade	防护等级
Operating Temperature	工作环境温度
Power Factor	功率因素
Life	使用寿命
THD	总谐波失真
Frequency Range	频率范围
Installation Pipe Diameter	安装管径
CRI	显色指数

10W
1pcs
6000k/4000k/3000k
1100lm
AC100~277V
IP65
-30~50°C
>0.9
>50000H
<15%
50/60HZ
/
>70

草坪灯 BOLLARD LIGHT

IP65  CE



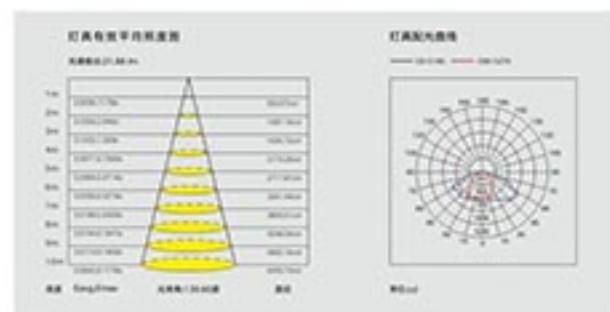
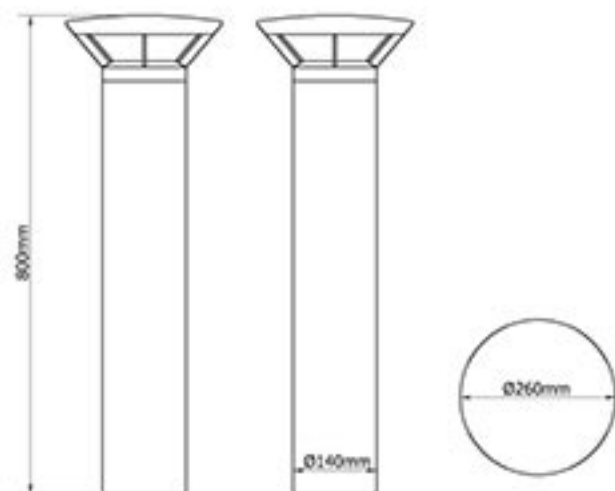

GENERAL PARAMETRES

常规参数

Rated power	额定功率
LED Quantity	LED数量
Color Temperature	色温
Luminous Flux	初始光通量
Input Voltage	输入电压
Protection Grade	防护等级
Operating Temperature	工作环境温度
Power Factor	功率因素
Life	使用寿命
THD	总谐波失真
Frequency Range	频率范围
Installation Pipe Diameter	安装管径
CRI	显色指数

10W
1pcs
6000k/4000k/3000k
1100lm
AC100~277V
IP65
-30~50°C
>0.9
>50000H
<15%
50/60HZ
/
>70

草坪灯 BOLLARD LIGHT

IP65 CCC CE

